

IAEA Safety Standards

for protecting people and the environment

Regulations for the Safe Transport of Radioactive Material

2005 Edition

Safety Requirements

No. TS-R-1



IAEA

International Atomic Energy Agency

IAEA SAFETY RELATED PUBLICATIONS

IAEA SAFETY STANDARDS

Under the terms of Article III of its Statute, the IAEA is authorized to establish or adopt standards of safety for protection of health and minimization of danger to life and property, and to provide for the application of these standards.

The publications by means of which the IAEA establishes standards are issued in the **IAEA Safety Standards Series**. This series covers nuclear safety, radiation safety, transport safety and waste safety, and also general safety (i.e. all these areas of safety). The publication categories in the series are **Safety Fundamentals**, **Safety Requirements** and **Safety Guides**.

Safety standards are coded according to their coverage: nuclear safety (NS), radiation safety (RS), transport safety (TS), waste safety (WS) and general safety (GS).

Information on the IAEA's safety standards programme is available at the IAEA Internet site

<http://www-ns.iaea.org/standards/>

The site provides the texts in English of published and draft safety standards. The texts of safety standards issued in Arabic, Chinese, French, Russian and Spanish, the IAEA Safety Glossary and a status report for safety standards under development are also available. For further information, please contact the IAEA at P.O. Box 100, A-1400 Vienna, Austria.

All users of IAEA safety standards are invited to inform the IAEA of experience in their use (e.g. as a basis for national regulations, for safety reviews and for training courses) for the purpose of ensuring that they continue to meet users' needs. Information may be provided via the IAEA Internet site or by post, as above, or by e-mail to Official.Mail@iaea.org.

OTHER SAFETY RELATED PUBLICATIONS

The IAEA provides for the application of the standards and, under the terms of Articles III and VIII.C of its Statute, makes available and fosters the exchange of information relating to peaceful nuclear activities and serves as an intermediary among its Member States for this purpose.

Reports on safety and protection in nuclear activities are issued in other publications series, in particular the **Safety Reports Series**. Safety Reports provide practical examples and detailed methods that can be used in support of the safety standards. Other IAEA series of safety related publications are the **Provision for the Application of Safety Standards Series**, the **Radiological Assessment Reports Series** and the International Nuclear Safety Group's **INSAG Series**. The IAEA also issues reports on radiological accidents and other special publications.

Safety related publications are also issued in the **Technical Reports Series**, the **IAEA-TECDOC Series**, the **Training Course Series** and the **IAEA Services Series**, and as **Practical Radiation Safety Manuals** and **Practical Radiation Technical Manuals**. Security related publications are issued in the **IAEA Nuclear Security Series**.

REGULATIONS
FOR THE SAFE TRANSPORT
OF RADIOACTIVE MATERIAL

2005 Edition

IAEA Safety Standards Series No. TS-R-1

Safety standards survey

The IAEA welcomes your response. Please see:

<http://www-ns.iaea.org/standards/feedback.htm>

The following States are Members of the International Atomic Energy Agency:

AFGHANISTAN	GREECE	PAKISTAN
ALBANIA	GUATEMALA	PANAMA
ALGERIA	HAITI	PARAGUAY
ANGOLA	HOLY SEE	PERU
ARGENTINA	HONDURAS	PHILIPPINES
ARMENIA	HUNGARY	POLAND
AUSTRALIA	ICELAND	PORTUGAL
AUSTRIA	INDIA	QATAR
AZERBAIJAN	INDONESIA	REPUBLIC OF MOLDOVA
BANGLADESH	IRAN, ISLAMIC REPUBLIC OF	ROMANIA
BELARUS	IRAQ	RUSSIAN FEDERATION
BELGIUM	IRELAND	SAUDI ARABIA
BENIN	ISRAEL	SENEGAL
BOLIVIA	ITALY	SERBIA AND MONTENEGRO
BOSNIA AND HERZEGOVINA	JAMAICA	SEYCHELLES
BOTSWANA	JAPAN	SIERRA LEONE
BRAZIL	JORDAN	SINGAPORE
BULGARIA	KAZAKHSTAN	SLOVAKIA
BURKINA FASO	KENYA	SLOVENIA
CAMEROON	KOREA, REPUBLIC OF	SOUTH AFRICA
CANADA	KUWAIT	SPAIN
CENTRAL AFRICAN REPUBLIC	KYRGYZSTAN	SRI LANKA
CHILE	LATVIA	SUDAN
CHINA	LEBANON	SWEDEN
COLOMBIA	LIBERIA	SWITZERLAND
COSTA RICA	LIBYAN ARAB JAMAHIRIYA	SYRIAN ARAB REPUBLIC
CÔTE D'IVOIRE	LIECHTENSTEIN	TAJKISTAN
CROATIA	LITHUANIA	THAILAND
CUBA	LUXEMBOURG	THE FORMER YUGOSLAV REPUBLIC OF MACEDONIA
CYPRUS	MADAGASCAR	TUNISIA
CZECH REPUBLIC	MALAYSIA	TURKEY
DEMOCRATIC REPUBLIC OF THE CONGO	MALI	UGANDA
DENMARK	MALTA	UKRAINE
DOMINICAN REPUBLIC	MARSHALL ISLANDS	UNITED ARAB EMIRATES
ECUADOR	MAURITANIA	UNITED KINGDOM OF GREAT BRITAIN AND NORTHERN IRELAND
EGYPT	MAURITIUS	UNITED REPUBLIC OF TANZANIA
EL SALVADOR	MEXICO	UNITED STATES OF AMERICA
ERITREA	MONACO	URUGUAY
ESTONIA	MONGOLIA	UZBEKISTAN
ETHIOPIA	MOROCCO	VENEZUELA
FINLAND	MYANMAR	VIETNAM
FRANCE	NAMIBIA	YEMEN
GABON	NETHERLANDS	ZAMBIA
GEORGIA	NEW ZEALAND	ZIMBABWE
GERMANY	NICARAGUA	
GHANA	NIGER	
	NIGERIA	
	NORWAY	

The Agency's Statute was approved on 23 October 1956 by the Conference on the Statute of the IAEA held at United Nations Headquarters, New York; it entered into force on 29 July 1957. The Headquarters of the Agency are situated in Vienna. Its principal objective is "to accelerate and enlarge the contribution of atomic energy to peace, health and prosperity throughout the world".

IAEA SAFETY STANDARDS SERIES No. TS-R-1

REGULATIONS
FOR THE SAFE TRANSPORT
OF RADIOACTIVE MATERIAL

2005 Edition

SAFETY REQUIREMENTS

INTERNATIONAL ATOMIC ENERGY AGENCY
VIENNA, 2005

COPYRIGHT NOTICE

All IAEA scientific and technical publications are protected by the terms of the Universal Copyright Convention as adopted in 1952 (Berne) and as revised in 1972 (Paris). The copyright has since been extended by the World Intellectual Property Organization (Geneva) to include electronic and virtual intellectual property. Permission to use whole or parts of texts contained in IAEA publications in printed or electronic form must be obtained and is usually subject to royalty agreements. Proposals for non-commercial reproductions and translations are welcomed and will be considered on a case by case basis. Enquiries should be addressed by email to the Publishing Section, IAEA, at sales.publications@iaea.org or by post to:

Sales and Promotion Unit, Publishing Section
International Atomic Energy Agency
Wagramer Strasse 5
P.O. Box 100
A-1400 Vienna
Austria
fax: +43 1 2600 29302
tel.: +43 1 2600 22417
<http://www.iaea.org/books>

© IAEA, 2005

Printed by the IAEA in Austria
August 2005
STI/PUB/1225

IAEA Library Cataloguing in Publication Data

Regulations for the safe transport of radioactive material : safety requirements — 2005 ed. — Vienna : International Atomic Energy Agency, 2005.

p. ; 24 cm. — (IAEA safety standards series, ISSN 1020-525X ; no. TS-R-1)

STI/PUB/1225

ISBN 92-0-103005-3

Includes bibliographical references.

1. Radioactive substances — Transportation — Safety measures.
2. Radioactive substances — Safety regulations. I. International Atomic Energy Agency. II. Series.

IAEAL

05-00399

FOREWORD

**by Mohamed ElBaradei
Director General**

The IAEA's Statute authorizes the Agency to establish safety standards to protect health and minimize danger to life and property — standards which the IAEA must use in its own operations, and which a State can apply by means of its regulatory provisions for nuclear and radiation safety. A comprehensive body of safety standards under regular review, together with the IAEA's assistance in their application, has become a key element in a global safety regime.

In the mid-1990s, a major overhaul of the IAEA's safety standards programme was initiated, with a revised oversight committee structure and a systematic approach to updating the entire corpus of standards. The new standards that have resulted are of a high calibre and reflect best practices in Member States. With the assistance of the Commission on Safety Standards, the IAEA is working to promote the global acceptance and use of its safety standards.

Safety standards are only effective, however, if they are properly applied in practice. The IAEA's safety services — which range in scope from engineering safety, operational safety, and radiation, transport and waste safety to regulatory matters and safety culture in organizations — assist Member States in applying the standards and appraise their effectiveness. These safety services enable valuable insights to be shared and I continue to urge all Member States to make use of them.

Regulating nuclear and radiation safety is a national responsibility, and many Member States have decided to adopt the IAEA's safety standards for use in their national regulations. For the Contracting Parties to the various international safety conventions, IAEA standards provide a consistent, reliable means of ensuring the effective fulfilment of obligations under the conventions. The standards are also applied by designers, manufacturers and operators around the world to enhance nuclear and radiation safety in power generation, medicine, industry, agriculture, research and education.

The IAEA takes seriously the enduring challenge for users and regulators everywhere: that of ensuring a high level of safety in the use of nuclear materials and radiation sources around the world. Their continuing utilization for the benefit of humankind must be managed in a safe manner, and the IAEA safety standards are designed to facilitate the achievement of that goal.

EDITORIAL NOTE

An appendix, when included, is considered to form an integral part of the standard and to have the same status as the main text. Annexes, footnotes and bibliographies, if included, are used to provide additional information or practical examples that might be helpful to the user.

The English version of the text is the authoritative version.

Reference to standards of other organizations is not to be construed as an endorsement on the part of the IAEA.

PREFACE

The IAEA first published Safety Series No. 6 in 1961 for application to the national and international transport of radioactive material by all modes of transport. Subsequent reviews, conducted in consultation with Member States and the international organizations concerned, resulted in five comprehensive revisions being published in 1964, 1967, 1973, 1985 and 1996.

In approving the first revision in 1964, the Board of Governors authorized the Director General to apply the Regulations to IAEA operations and IAEA assisted operations. The Director General was also authorized to recommend to Member States and international organizations that the Regulations be taken as the basis for corresponding national and international regulations. By 1969, the Regulations had been adopted by almost all international organizations concerned with transport and were used by many Member States for their own regulations.

Through the worldwide adoption of the IAEA's Regulations for all modes of transport, a very high standard of safety in transport has been achieved. In the revisions since the first edition, attempts have been made to find a balance between the need to take account of technical advances and operational experience, and the desirability of providing a stable framework of regulatory requirements. One of the aims of this approach is to allow packages designed to previous versions of the Regulations to continue to be used for a reasonable period of time. It is recognized that not all regulatory changes can be implemented simultaneously; Member States and international organizations are therefore invited, in adopting this revision, to provide for use of both the 'old' requirements and the 'new' ones during a period of transition that may last for a few years. It is further recommended that adoption of these revised Regulations occur within a period of five years from publication to achieve worldwide harmonization of their application. In implementing the provisions of these Regulations, it may be necessary for Member States to issue complementary national regulations. Except as necessary for solely domestic purposes, such national regulations should not conflict with these Regulations.

The IAEA had previously published two companion standards to Safety Series No. 6: one entitled 'Advisory Material for the IAEA Regulations for the Safe Transport of Radioactive Material (1985 Edition)', Safety Series No. 37, and the other entitled 'Explanatory Material for the IAEA Regulations for the Safe Transport of Radioactive Material', Safety Series No. 7. For the benefit of designers and manufacturers of packagings, consignors, carriers, competent authorities and others, Safety Series No. 37 provided advisory information about the technical requirements of the Regulations and about the methods and technology that may be employed to fulfil them; the so called 'how' of

these provisions. Safety Series No. 7 provided explanatory information on the intent and rationale of the regulatory requirements; the so called 'why' of these provisions. Its purpose was to help comprehension of the regulatory standards, to promote compliance, public acceptance and future development of the Regulations. In support of the 1996 Edition (Revised) of the Regulations, the IAEA published a companion volume 'Advisory Material for the IAEA Regulations for the Safe Transport of Radioactive Material, IAEA Safety Standards Series No. TS-G-1.1 (ST-2)' in 2002, that combines both the advisory and explanatory material. Member States and international organizations concerned are invited to take note of this companion publication and to bring it to the notice of persons and organizations affected by these Regulations.

This publication is called the 2005 Edition of the Transport Regulations. It includes amendments to the 1996 Edition (As Amended 2003) arising from the second cycle of the biennial review and revision process, as agreed by the Transport Safety Standards Committee (TRANSSC) at its ninth meeting in March 2004, as endorsed by the Commission on Safety Standards at its meeting in June 2004 and as approved by the IAEA's Board of Governors in November 2004. Although this publication is identified as a new edition, there are no changes that affect the administrative and approval requirements in Section VIII.

The IAEA officers responsible for this Safety Standard were N. Bruno and M.E. Wangler.

IAEA SAFETY STANDARDS

SAFETY THROUGH INTERNATIONAL STANDARDS

While safety is a national responsibility, international standards and approaches to safety promote consistency, help to provide assurance that nuclear and radiation related technologies are used safely, and facilitate international technical cooperation and trade.

The standards also provide support for States in meeting their international obligations. One general international obligation is that a State must not pursue activities that cause damage in another State. More specific obligations on Contracting States are set out in international safety related conventions. The internationally agreed IAEA safety standards provide the basis for States to demonstrate that they are meeting these obligations.

THE IAEA STANDARDS

The IAEA safety standards have a status derived from the IAEA's Statute, which authorizes the Agency to establish standards of safety for nuclear and radiation related facilities and activities and to provide for their application.

The safety standards reflect an international consensus on what constitutes a high level of safety for protecting people and the environment.

They are issued in the IAEA Safety Standards Series, which has three categories:

Safety Fundamentals

- Presenting the objectives, concepts and principles of protection and safety and providing the basis for the safety requirements.

Safety Requirements

- Establishing the requirements that must be met to ensure the protection of people and the environment, both now and in the future. The requirements, which are expressed as 'shall' statements, are governed by the objectives, concepts and principles of the Safety Fundamentals. If they are not met, measures must be taken to reach or restore the required level of safety. The Safety Requirements use regulatory language to enable them to be incorporated into national laws and regulations.

Safety Guides

- Providing recommendations and guidance on how to comply with the Safety Requirements. Recommendations in the Safety Guides are expressed as 'should' statements. It is recommended to take the measures stated or equivalent alternative measures. The Safety Guides present international good practices and increasingly they reflect best practices to

help users striving to achieve high levels of safety. Each Safety Requirements publication is supplemented by a number of Safety Guides, which can be used in developing national regulatory guides.

The IAEA safety standards need to be complemented by industry standards and must be implemented within appropriate national regulatory infrastructures to be fully effective. The IAEA produces a wide range of technical publications to help States in developing these national standards and infrastructures.

MAIN USERS OF THE STANDARDS

As well as by regulatory bodies and governmental departments, authorities and agencies, the standards are used by authorities and operating organizations in the nuclear industry; by organizations that design, manufacture and apply nuclear and radiation related technologies, including operating organizations of facilities of various types; by users and others involved with radiation and radioactive material in medicine, industry, agriculture, research and education; and by engineers, scientists, technicians and other specialists. The standards are used by the IAEA itself in its safety reviews and for developing education and training courses.

DEVELOPMENT PROCESS FOR THE STANDARDS

The preparation and review of safety standards involves the IAEA Secretariat and four safety standards committees for safety in the areas of nuclear safety (NUSSC), radiation safety (RASSC), the safety of radioactive waste (WASSC) and the safe transport of radioactive material (TRANSSC), and a Commission on Safety Standards (CSS), which oversees the entire safety standards programme. All IAEA Member States may nominate experts for the safety standards committees and may provide comments on draft standards. The membership of the CSS is appointed by the Director General and includes senior government officials having responsibility for establishing national standards.

For Safety Fundamentals and Safety Requirements, the drafts endorsed by the Commission are submitted to the IAEA Board of Governors for approval for publication. Safety Guides are published on the approval of the Director General.

Through this process the standards come to represent a consensus view of the IAEA's Member States. The findings of the United Nations Scientific Committee on the Effects of Atomic Radiation (UNSCEAR) and the recommendations of international expert bodies, notably the International Commission on Radiological Protection (ICRP), are taken into account in developing the standards. Some standards are developed in cooperation with other bodies in the United Nations system or other specialized agencies, including the Food and Agriculture Organization of the United Nations, the International

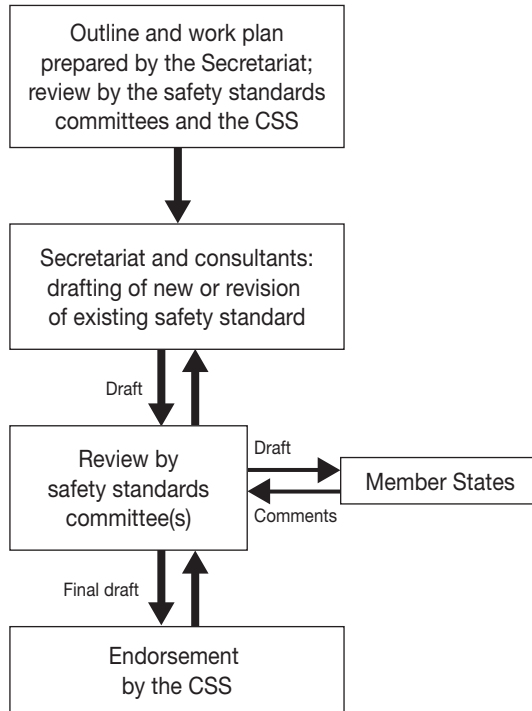

The process for developing a new safety standard or revising an existing one.

Labour Organization, the OECD Nuclear Energy Agency, the Pan American Health Organization and the World Health Organization.

The safety standards are kept up to date: five years after publication they are reviewed to determine whether revision is necessary.

APPLICATION AND SCOPE OF THE STANDARDS

The IAEA Statute makes the safety standards binding on the IAEA in relation to its own operations and on States in relation to operations assisted by the IAEA. Any State wishing to enter into an agreement with the IAEA concerning any form of Agency assistance is required to comply with the requirements of the safety standards that pertain to the activities covered by the agreement.

International conventions also contain similar requirements to those in the safety standards, and make them binding on contracting parties. The Safety Fundamentals were used as the basis for the development of the Convention on Nuclear Safety and the Joint Convention on the Safety of Spent Fuel Management and on the Safety of Radioactive Waste Management. The Safety

Requirements on Preparedness and Response for a Nuclear or Radiological Emergency reflect the obligations on States under the Convention on Early Notification of a Nuclear Accident and the Convention on Assistance in the Case of a Nuclear Accident or Radiological Emergency.

The safety standards, incorporated into national legislation and regulations and supplemented by international conventions and detailed national requirements, establish a basis for protecting people and the environment. However, there will also be special aspects of safety that need to be assessed case by case at the national level. For example, many of the safety standards, particularly those addressing planning or design aspects of safety, are intended to apply primarily to new facilities and activities. The requirements and recommendations specified in the IAEA safety standards might not be fully met at some facilities built to earlier standards. The way in which the safety standards are to be applied to such facilities is a decision for individual States.

INTERPRETATION OF THE TEXT

The safety standards use the form 'shall' in establishing international consensus requirements, responsibilities and obligations. Many requirements are not addressed to a specific party, the implication being that the appropriate party or parties should be responsible for fulfilling them. Recommendations are expressed as 'should' statements, indicating an international consensus that it is necessary to take the measures recommended (or equivalent alternative measures) for complying with the requirements.

Safety related terms are to be interpreted as stated in the IAEA Safety Glossary (<http://www-ns.iaea.org/standards/safety-glossary.htm>). Otherwise, words are used with the spellings and meanings assigned to them in the latest edition of The Concise Oxford Dictionary. For Safety Guides, the English version of the text is the authoritative version.

The background and context of each standard within the Safety Standards Series and its objective, scope and structure are explained in Section 1, Introduction, of each publication.

Material for which there is no appropriate place in the main text (e.g. material that is subsidiary to or separate from the main text, is included in support of statements in the main text, or describes methods of calculation, experimental procedures or limits and conditions) may be presented in appendices or annexes.

An appendix, if included, is considered to form an integral part of the standard. Material in an appendix has the same status as the main text and the IAEA assumes authorship of it. Annexes and footnotes to the main text, if included, are used to provide practical examples or additional information or explanation. An annex is not an integral part of the main text. Annex material published by the IAEA is not necessarily issued under its authorship; material published in standards that is under other authorship may be presented in annexes. Extraneous material presented in annexes is excerpted and adapted as necessary to be generally useful.

CONTENTS

(Paragraph numbers are given in parentheses)

SECTION I.	INTRODUCTION	1
	Background (101–103)	1
	Objective (104–105).....	2
	Scope (106–109).....	2
	Structure (110)	3
SECTION II.	DEFINITIONS (201–248)	5
SECTION III.	GENERAL PROVISIONS	17
	Radiation protection (301–303)	17
	Emergency response (304–305)	17
	Quality assurance (306).....	18
	Compliance assurance (307–308).....	18
	Non-compliance (309).....	19
	Special arrangement (310)	19
	Training (311–314).....	20
SECTION IV.	ACTIVITY LIMITS AND MATERIAL RESTRICTIONS	23
	Basic radionuclide values (401)	23
	Determination of basic radionuclide values (402–406).....	23
	Contents limits for packages (407–419)	45
SECTION V.	REQUIREMENTS AND CONTROLS FOR TRANSPORT	49
	Requirements before the first shipment (501)	49
	Requirements before each shipment (502).....	49
	Transport of other goods (503–506)	50
	Other dangerous properties of contents (507).....	51
	Requirements and controls for contamination and for leaking packages (508–514).....	51

Requirements and controls for transport of excepted packages (515–520)	52
Requirements and controls for transport of LSA material and SCO in industrial packages or unpackaged (521–525)	54
Determination of transport index (526–527)	55
Determination of criticality safety index (528–529)	57
Limits on transport index, criticality safety index and radiation levels for packages and overpacks (530–532).	57
Categories (533)	58
Marking, labelling and placarding (534–548)	59
Consignor’s responsibilities (549–562)	70
Transport and storage in transit (563–581)	73
Customs operations (582)	80
Undeliverable consignments (583)	80

SECTION VI. REQUIREMENTS FOR RADIOACTIVE MATERIALS AND FOR PACKAGINGS AND PACKAGES 81

Requirements for radioactive materials (601–605)	81
General requirements for all packagings and packages (606–616)	82
Additional requirements for packages transported by air (617–619)	83
Requirements for excepted packages (620)	84
Requirements for industrial packages (621–628)	84
Requirements for packages containing uranium hexafluoride (629–632)	86
Requirements for Type A packages (633–649)	87
Requirements for Type B(U) packages (650–664)	89
Requirements for Type B(M) packages (665–666)	92
Requirements for Type C packages (667–670)	92
Requirements for packages containing fissile material (671–682)	93

SECTION VII. TEST PROCEDURES 99

Demonstration of compliance (701–702)	99
Leaching test for LSA-III material and low dispersible radioactive material (703)	99
Tests for special form radioactive material (704–711)	100
Tests for low dispersible radioactive material (712)	102
Tests for packages (713–737)	103

SECTION VIII. APPROVAL AND ADMINISTRATIVE REQUIREMENTS.....	111
General (801–802).....	111
Approval of special form radioactive material and low dispersible radioactive material (803–804).....	111
Approval of package designs (805–814).....	112
Transitional arrangements (815–818).....	115
Notification and registration of serial numbers (819).....	116
Approval of shipments (820–823).....	116
Approval of shipments under special arrangement (824–826).....	117
Competent authority approval certificates (827–829).....	118
Contents of approval certificates (830–833).....	121
Validation of certificates (834).....	126
REFERENCES	127
ANNEX I: SUMMARY OF APPROVAL AND PRIOR NOTIFICATION REQUIREMENTS.....	129
ANNEX II: CONVERSION FACTORS AND PREFIXES	134
CONTRIBUTORS TO DRAFTING AND REVIEW.....	137
BODIES FOR THE ENDORSEMENT OF IAEA SAFETY STANDARDS	145
INDEX	149
LIST OF TABLES	
Table 1 Basic radionuclide values.....	24
Table 2 Basic radionuclide values for unknown radionuclides or mixtures.....	45
Table 3 Activity limits for excepted packages.....	46
Table 4 Industrial package requirements for LSA material and SCO	55
Table 5 Conveyance activity limits for LSA material and SCO in industrial packages or unpackaged.....	56
Table 6 Multiplication factors for tanks, freight containers, and unpackaged LSA-I and SCO-I.....	57
Table 7 Categories of packages and overpacks.....	58

Table 8	Excerpts from list of United Nations numbers, proper shipping names and descriptions, subsidiary risks and their relationship to the Schedules.	60
Table 9	TI limits for freight containers and conveyances not under exclusive use	75
Table 10	CSI limits for freight containers and conveyances containing fissile material	76
Table 11	Insolation data	90
Table 12	Consignment mass limits for exceptions from the requirements for packages containing fissile material	95
Table 13	Free drop distance for testing packages to normal conditions of transport	105

Section I

INTRODUCTION

BACKGROUND

101. These Regulations establish standards of safety which provide an acceptable level of control of the radiation, criticality and thermal hazards to persons, property and the environment that are associated with the transport of *radioactive material*. These Regulations utilize the principles set forth in both the “Radiation Protection and the Safety of Radiation Sources”, Safety Series No. 120 [1] and the “International Basic Safety Standards for Protection against Ionizing Radiation and for the Safety of Radiation Sources”, Safety Series No. 115 [2], jointly sponsored by the Food and Agriculture Organization of the United Nations, the IAEA, the International Labour Organization, the OECD Nuclear Energy Agency, the Pan American Health Organization and the World Health Organization. Thus, compliance with these Regulations is deemed to satisfy the principles of the Basic Safety Standards in respect of transport.

102. This Safety Standard is supplemented by a hierarchy of Safety Guides including “Advisory Material for the IAEA Regulations for the Safe Transport of Radioactive Material (1996 Edition)”, IAEA Safety Standards Series No. TS-G-1.1 (ST-2) [3], “Planning and Preparing for Emergency Response to Transport Accidents Involving Radioactive Material”, IAEA Safety Standards Series No. TS-G-1.2 (ST-3) [4], “Compliance Assurance for the Safe Transport of Radioactive Material”, IAEA Safety Standards Series No. TS-G-1.4 [5] and “Quality Assurance for the Safe Transport of Radioactive Material”, IAEA Safety Standards Series No. TS-G-1.3 [6].

103. In certain parts of these Regulations, a particular action is prescribed, but the responsibility for carrying out the action is not specifically assigned to any particular legal person. Such responsibility may vary according to the laws and customs of different countries and the international conventions into which these countries have entered. For the purpose of these Regulations, it is not necessary to make this assignment, but only to identify the action itself. It remains the prerogative of each government to assign this responsibility.

SECTION I

OBJECTIVE

104. The objective of these Regulations is to protect persons, property and the environment from the effects of radiation during the transport of *radioactive material*. This protection is achieved by requiring:

- (a) containment of the *radioactive contents*;
- (b) control of external *radiation levels*;
- (c) prevention of criticality; and
- (d) prevention of damage caused by heat.

These requirements are satisfied firstly by applying a graded approach to contents limits for *packages* and *conveyances* and to performance standards applied to *package designs* depending upon the hazard of the *radioactive contents*. Secondly, they are satisfied by imposing requirements on the *design* and operation of *packages* and on the maintenance of *packagings*, including a consideration of the nature of the *radioactive contents*. Finally, they are satisfied by requiring administrative controls including, where appropriate, *approval* by *competent authorities*.

105. In the transport of *radioactive material* the safety of persons, who are either members of the public or workers, is assured when these Regulations are complied with. Confidence in this regard is achieved through *quality assurance* and *compliance assurance* programmes.

SCOPE

106. These Regulations apply to the transport of *radioactive material* by all modes on land, water or in the air, including transport which is incidental to the use of the *radioactive material*. Transport comprises all operations and conditions associated with and involved in the movement of *radioactive material*; these include the design, manufacture, maintenance and repair of *packaging*, and the preparation, consigning, loading, carriage including in-transit storage, unloading and receipt at the final destination of loads of *radioactive material* and *packages*. A graded approach is applied to the performance standards in these Regulations that is characterized by three general severity levels:

- (a) routine conditions of transport (incident free);
- (b) normal conditions of transport (minor mishaps);
- (c) accident conditions of transport.

INTRODUCTION

107. The Regulations do not apply to:

- (a) radioactive material that is an integral part of the means of transport;
- (b) radioactive material moved within an establishment which is subject to appropriate safety regulations in force in the establishment and where the movement does not involve public roads or railways;
- (c) radioactive material implanted or incorporated into a person or live animal for diagnosis or treatment;
- (d) radioactive material in consumer products which have received regulatory approval, following their sale to the end user;
- (e) natural material and ores containing naturally occurring radionuclides that are either in their natural state, or have been processed only for purposes other than for the extraction of the radionuclides, and that are not intended to be processed for use of these radionuclides, provided that the activity concentration of the material does not exceed 10 times the values specified in para. 401(b), or calculated in accordance with paras 402–406;
- (f) non-radioactive solid objects with radioactive substances present on any surfaces in quantities not in excess of the levels defined in para. 214.

108. These Regulations do not specify controls such as routeing or physical protection which may be instituted for reasons other than radiological safety. Any such controls shall take into account radiological and non-radiological hazards, and shall not detract from the standards of safety which these Regulations are intended to provide.

109. For *radioactive material* having subsidiary risks, and for transport of *radioactive material* with other dangerous goods, the relevant transport regulations for dangerous goods of each of the countries through or into which the material is to be transported shall apply in addition to these Regulations.

STRUCTURE

110. This publication is structured so that Section II defines the terms that are required for the purposes of the Regulations; Section III provides general provisions; Section IV provides activity limits and material restrictions used throughout these Regulations; Section V provides requirements and controls for transport; Section VI provides requirements for radioactive material and for packagings and packages; Section VII provides requirements for test

SECTION I

procedures; Section VIII provides requirements for approvals and administration.

Section II

DEFINITIONS

The following definitions shall apply for the purposes of these Regulations:

A_1 and A_2

201. A_1 shall mean the activity value of *special form radioactive material* which is listed in Table 1 or derived in Section IV and is used to determine the activity limits for the requirements of these Regulations. A_2 shall mean the activity value of *radioactive material*, other than *special form radioactive material*, which is listed in Table 1 or derived in Section IV and is used to determine the activity limits for the requirements of these Regulations.

Aircraft

202. *Cargo aircraft* shall mean any aircraft, other than a *passenger aircraft*, which is carrying goods or property.

203. *Passenger aircraft* shall mean an aircraft that carries any person other than a crew member, a *carrier's* employee in an official capacity, an authorized representative of an appropriate national authority, or a person accompanying a *consignment*.

Approval

204. *Multilateral approval* shall mean approval by the relevant *competent authority* of the country of origin of the *design* or *shipment*, as applicable, and also, where the *consignment* is to be transported through or into any other country, approval by the *competent authority* of that country. The term "through or into" specifically excludes "over", i.e. the approval and notification requirements shall not apply to a country over which *radioactive material* is carried in an *aircraft*, provided that there is no scheduled stop in that country.

205. *Unilateral approval* shall mean an approval of a *design* which is required to be given by the *competent authority* of the country of origin of the *design* only.

SECTION II

Carrier

206. *Carrier* shall mean any person, organization or government undertaking the carriage of *radioactive material* by any means of transport. The term includes both carriers for hire or reward (known as common or contract carriers in some countries) and carriers on own account (known as private carriers in some countries).

Competent authority

207. *Competent authority* shall mean any national or international regulatory body or authority designated or otherwise recognized as such for any purpose in connection with these Regulations.

Compliance assurance

208. *Compliance assurance* shall mean a systematic programme of measures applied by a *competent authority* which is aimed at ensuring that the provisions of these Regulations are met in practice.

Confinement system

209. *Confinement system* shall mean the assembly of *fissile material* and *packaging* components specified by the designer and agreed to by the *competent authority* as intended to preserve criticality safety.

Consignee

210. *Consignee* shall mean any person, organization or government which receives a *consignment*.

Consignment

211. *Consignment* shall mean any *package* or *packages*, or load of *radioactive material*, presented by a *consignor* for transport.

Consignor

212. *Consignor* shall mean any person, organization or government which prepares a *consignment* for transport.

DEFINITIONS

Containment system

213. *Containment system* shall mean the assembly of components of the *packaging* specified by the designer as intended to retain the *radioactive material* during transport.

Contamination

214. *Contamination* shall mean the presence of a radioactive substance on a surface in quantities in excess of 0.4 Bq/cm² for beta and gamma emitters and *low toxicity alpha emitters*, or 0.04 Bq/cm² for all other alpha emitters.

215. *Non-fixed contamination* shall mean *contamination* that can be removed from a surface during routine conditions of transport.

216. *Fixed contamination* shall mean *contamination* other than *non-fixed contamination*.

Conveyance

217. *Conveyance* shall mean

- (a) for transport by road or rail: any *vehicle*,
- (b) for transport by water: any *vessel*, or any hold, compartment, or *defined deck area* of a *vessel*, and
- (c) for transport by air: any *aircraft*.

Criticality safety index

218. *Criticality safety index (CSI)* assigned to a *package*, *overpack* or *freight container* containing *fissile material* shall mean a number which is used to provide control over the accumulation of *packages*, *overpacks* or *freight containers* containing *fissile material*.

Defined deck area

219. *Defined deck area* shall mean the area, of the weather deck of a *vessel*, or of a *vehicle* deck of a roll-on/roll-off ship or a ferry, which is allocated for the stowage of *radioactive material*.

SECTION II

Design

220. *Design* shall mean the description of *special form radioactive material*, *low dispersible radioactive material*, *package* or *packaging* which enables such an item to be fully identified. The description may include specifications, engineering drawings, reports demonstrating compliance with regulatory requirements, and other relevant documentation.

Exclusive use

221. *Exclusive use* shall mean the sole use, by a single *consignor*, of a *conveyance* or of a large *freight container*, in respect of which all initial, intermediate and final loading and unloading is carried out in accordance with the directions of the *consignor* or *consignee*.

Fissile material

222. *Fissile material* shall mean uranium-233, uranium-235, plutonium-239, plutonium-241, or any combination of these radionuclides. Excepted from this definition is:

- (a) *natural uranium* or *depleted uranium* which is unirradiated, and
- (b) *natural uranium* or *depleted uranium* which has been irradiated in thermal reactors only.

Freight container

223. *Freight container* shall mean an article of transport equipment designed to facilitate the transport of goods, either packaged or unpackaged, by one or more modes of transport without intermediate reloading which is of a permanent enclosed character, rigid and strong enough for repeated use, and must be fitted with devices facilitating its handling, particularly in transfer between *conveyances* and from one mode of transport to another. A small *freight container* is that which has either any overall outer dimension less than 1.5 m, or an internal volume of not more than 3 m³. Any other *freight container* is considered to be a large *freight container*.

DEFINITIONS

Intermediate bulk container

224. *Intermediate bulk container (IBC)* shall mean a portable *packaging* that:

- (a) has a capacity of not more than 3 m³,
- (b) is designed for mechanical handling,
- (c) is resistant to the stresses produced in handling and transport, as determined by performance tests, and
- (d) is designed to conform to the standards in the chapter on Recommendations on Intermediate Bulk Containers (IBCs) of the United Nations Recommendations on the Transport of Dangerous Goods [7].

Low dispersible radioactive material

225. *Low dispersible radioactive material* shall mean either a solid *radioactive material* or a solid *radioactive material* in a sealed capsule, that has limited dispersibility and is not in powder form.

Low specific activity material

226. *Low specific activity (LSA) material* shall mean *radioactive material* which by its nature has a limited *specific activity*, or *radioactive material* for which limits of estimated average *specific activity* apply. External shielding materials surrounding the *LSA material* shall not be considered in determining the estimated average *specific activity*.

LSA material shall be in one of three groups:

- (a) *LSA-I*
 - (i) Uranium and thorium ores and concentrates of such ores, and other ores containing naturally occurring radionuclides which are intended to be processed for the use of these radionuclides;
 - (ii) Natural uranium, depleted uranium, natural thorium or their compounds or mixtures, providing they are unirradiated and in solid or liquid form;
 - (iii) *Radioactive material* for which the A_2 value is unlimited, excluding *fissile material* in quantities not excepted under para. 672; or
 - (iv) Other *radioactive material* in which the activity is distributed throughout and the estimated average *specific activity* does not exceed 30 times the values for activity concentration specified in

SECTION II

paras 401–406, excluding *fissile material* in quantities not excepted under para. 672.

- (b) *LSA-II*
 - (i) Water with tritium concentration up to 0.8 TBq/L; or
 - (ii) Other material in which the activity is distributed throughout and the estimated average *specific activity* does not exceed $10^{-4}A_2/g$ for solids and gases, and $10^{-5}A_2/g$ for liquids.
- (c) *LSA-III*

Solids (e.g. consolidated wastes, activated materials), excluding powders, in which:

 - (i) The *radioactive material* is distributed throughout a solid or a collection of solid objects, or is essentially uniformly distributed in a solid compact binding agent (such as concrete, bitumen, ceramic, etc.);
 - (ii) The *radioactive material* is relatively insoluble, or it is intrinsically contained in a relatively insoluble matrix, so that, even under loss of *packaging*, the loss of *radioactive material* per *package* by leaching when placed in water for seven days would not exceed $0.1A_2$; and
 - (iii) The estimated average *specific activity* of the solid, excluding any shielding material, does not exceed $2 \times 10^{-3}A_2/g$.

Low toxicity alpha emitters

227. *Low toxicity alpha emitters* are: *natural uranium*; *depleted uranium*; natural thorium; uranium-235 or uranium-238; thorium-232; thorium-228 and thorium-230 when contained in ores or physical and chemical concentrates; or alpha emitters with a half-life of less than 10 days.

Maximum normal operating pressure

228. *Maximum normal operating pressure* shall mean the maximum pressure above atmospheric pressure at mean sea-level that would develop in the *containment system* in a period of one year under the conditions of temperature and solar radiation corresponding to environmental conditions in the absence of venting, external cooling by an ancillary system, or operational controls during transport.

DEFINITIONS

Overpack

229. *Overpack* shall mean an enclosure such as a box or bag which is used by a single *consignor* to facilitate as a handling unit a *consignment* of one or more *packages* for convenience of handling, stowage and carriage.

Package

230. *Package* shall mean the *packaging* with its *radioactive contents* as presented for transport. The types of *packages* covered by these Regulations, which are subject to the activity limits and material restrictions of Section IV and meet the corresponding requirements, are:

- (a) *Excepted package*;
- (b) *Industrial package Type 1 (Type IP-1)*;
- (c) *Industrial package Type 2 (Type IP-2)*;
- (d) *Industrial package Type 3 (Type IP-3)*;
- (e) *Type A package*;
- (f) *Type B(U) package*;
- (g) *Type B(M) package*;
- (h) *Type C package*.

Packages containing *fissile material* or uranium hexafluoride are subject to additional requirements.

Packaging

231. *Packaging* shall mean the assembly of components necessary to enclose the *radioactive contents* completely. It may, in particular, consist of one or more receptacles, absorbent materials, spacing structures, radiation shielding and service equipment for filling, emptying, venting and pressure relief; devices for cooling, absorbing mechanical shocks, handling and tie-down, and thermal insulation; and service devices integral to the *package*. The *packaging* may be a box, drum or similar receptacle, or may also be a *freight container*, *tank* or *intermediate bulk container*.

Quality assurance

232. *Quality assurance* shall mean a systematic programme of controls and inspections applied by any organization or body involved in the transport of

SECTION II

radioactive material which is aimed at providing adequate confidence that the standard of safety prescribed in these Regulations is achieved in practice.

Radiation level

233. *Radiation level* shall mean the corresponding dose rate expressed in millisieverts per hour.

Radiation Protection Programme

234. *Radiation Protection Programme* shall mean systematic arrangements which are aimed at providing adequate consideration of radiation protection measures.

Radioactive contents

235. *Radioactive contents* shall mean the *radioactive material* together with any contaminated or activated solids, liquids and gases within the *packaging*.

Radioactive material

236. *Radioactive material* shall mean any material containing radionuclides where both the activity concentration and the total activity in the *consignment* exceed the values specified in paras 401–406.

Shipment

237. *Shipment* shall mean the specific movement of a *consignment* from origin to destination.

Special arrangement

238. *Special arrangement* shall mean those provisions, approved by the *competent authority*, under which *consignments* which do not satisfy all the applicable requirements of these Regulations may be transported.

Special form radioactive material

239. *Special form radioactive material* shall mean either an indispersible solid *radioactive material* or a sealed capsule containing *radioactive material*.

DEFINITIONS

Specific activity

240. *Specific activity* of a radionuclide shall mean the activity per unit mass of that nuclide. The *specific activity* of a material shall mean the activity per unit mass of the material in which the radionuclides are essentially uniformly distributed.

Surface contaminated object

241. *Surface contaminated object (SCO)* shall mean a solid object which is not itself radioactive but which has *radioactive material* distributed on its surfaces. *SCO* shall be in one of two groups:

- (a) *SCO-I*: A solid object on which:
 - (i) the *non-fixed contamination* on the accessible surface averaged over 300 cm² (or the area of the surface if less than 300 cm²) does not exceed 4 Bq/cm² for beta and gamma emitters and *low toxicity alpha emitters*, or 0.4 Bq/cm² for all other alpha emitters; and
 - (ii) the *fixed contamination* on the accessible surface averaged over 300 cm² (or the area of the surface if less than 300 cm²) does not exceed 4×10^4 Bq/cm² for beta and gamma emitters and *low toxicity alpha emitters*, or 4×10^3 Bq/cm² for all other alpha emitters; and
 - (iii) the *non-fixed contamination* plus the *fixed contamination* on the inaccessible surface averaged over 300 cm² (or the area of the surface if less than 300 cm²) does not exceed 4×10^4 Bq/cm² for beta and gamma emitters and *low toxicity alpha emitters*, or 4×10^3 Bq/cm² for all other alpha emitters.
- (b) *SCO-II*: A solid object on which either the *fixed* or *non-fixed contamination* on the surface exceeds the applicable limits specified for *SCO-I* in (a) above and on which:
 - (i) the *non-fixed contamination* on the accessible surface averaged over 300 cm² (or the area of the surface if less than 300 cm²) does not exceed 400 Bq/cm² for beta and gamma emitters and *low toxicity alpha emitters*, or 40 Bq/cm² for all other alpha emitters; and
 - (ii) the *fixed contamination* on the accessible surface, averaged over 300 cm² (or the area of the surface if less than 300 cm²) does not exceed 8×10^5 Bq/cm² for beta and gamma emitters and *low toxicity alpha emitters*, or 8×10^4 Bq/cm² for all other alpha emitters; and
 - (iii) the *non-fixed contamination* plus the *fixed contamination* on the inaccessible surface averaged over 300 cm² (or the area of the surface if less than 300 cm²) does not exceed 8×10^5 Bq/cm² for

SECTION II

beta and gamma emitters and *low toxicity alpha emitters*, or 8×10^4 Bq/cm² for all other alpha emitters.

Tank

242. *Tank* shall mean a tank container, a portable tank, a road tank vehicle, a rail tank wagon or a receptacle with a capacity of not less than 450 litres to contain liquids, powders, granules, slurries or solids which are loaded as gas or liquid and subsequently solidified, and of not less than 1000 litres to contain gases. A tank container shall be capable of being carried on land or on sea and of being loaded and discharged without the need of removal of its structural equipment, shall possess stabilizing members and tie-down attachments external to the shell, and shall be capable of being lifted when full.

Transport index

243. *Transport index (TI)* assigned to a *package*, *overpack* or *freight container*, or to unpackage *LSA-I* or *SCO-I*, shall mean a number which is used to provide control over radiation exposure.

Unirradiated thorium

244. *Unirradiated thorium* shall mean thorium containing not more than 10^{-7} g of uranium-233 per gram of thorium-232.

Unirradiated uranium

245. *Unirradiated uranium* shall mean uranium containing not more than 2×10^3 Bq of plutonium per gram of uranium-235, not more than 9×10^6 Bq of fission products per gram of uranium-235 and not more than 5×10^{-3} g of uranium-236 per gram of uranium-235.

Uranium – natural, depleted, enriched

246. *Natural uranium* shall mean uranium (which may be chemically separated) containing the naturally occurring distribution of uranium isotopes (approximately 99.28% uranium-238 and 0.72% uranium-235 by mass). *Depleted uranium* shall mean uranium containing a lesser mass percentage of uranium-235 than *natural uranium*. *Enriched uranium* shall mean uranium containing a greater mass percentage of uranium-235 than 0.72%. In all cases, a very small mass percentage of uranium-234 is present.

DEFINITIONS

Vehicle

247. *Vehicle* shall mean a road vehicle (including an articulated vehicle, i.e. a tractor and semi-trailer combination) or railroad car or railway wagon. Each trailer shall be considered as a separate *vehicle*.

Vessel

248. *Vessel* shall mean any seagoing vessel or inland waterway craft used for carrying cargo.

Section III

GENERAL PROVISIONS

RADIATION PROTECTION

301. Doses to persons shall be below the relevant dose limits. Protection and safety shall be optimized in order that the magnitude of individual doses, the number of persons exposed, and the likelihood of incurring exposure shall be kept as low as reasonably achievable, economic and social factors being taken into account, within the restriction that the doses to individuals be subject to dose constraints. A structured and systematic approach shall be adopted and shall include consideration of the interfaces between transport and other activities.

302. A *Radiation Protection Programme* shall be established for the transport of *radioactive material*. The nature and extent of the measures to be employed in the programme shall be related to the magnitude and likelihood of radiation exposures. The programme shall incorporate the requirements of paras 301, 303–305 and 311. Programme documents shall be available, on request, for inspection by the relevant *competent authority*.

303. For occupational exposures arising from transport activities, where it is assessed that the effective dose:

- (a) is likely to be between 1 and 6 mSv in a year, a dose assessment programme via workplace monitoring or individual monitoring shall be conducted;
- (b) is likely to exceed 6 mSv in a year, individual monitoring shall be conducted.

When individual monitoring or workplace monitoring is conducted, appropriate records shall be kept.

EMERGENCY RESPONSE

304. In the event of accidents or incidents during the transport of *radioactive material*, emergency provisions, as established by relevant national and/or

SECTION III

international organizations, shall be observed to protect persons, property and the environment. Appropriate guidelines for such provisions are contained in Ref. [4].

305. Emergency procedures shall take into account the formation of other dangerous substances that may result from the reaction between the contents of a *consignment* and the environment in the event of an accident.

QUALITY ASSURANCE

306. *Quality assurance* programmes based on international, national or other standards acceptable to the *competent authority* shall be established and implemented for the design, manufacture, testing, documentation, use, maintenance and inspection of all *special form radioactive material*, *low dispersible radioactive material* and *packages* and for transport and in-transit storage operations to ensure compliance with the relevant provisions of these Regulations. Certification that the *design* specification has been fully implemented shall be available to the *competent authority*. The manufacturer, *consignor* or user shall be prepared to provide facilities for *competent authority* inspection during manufacture and use and to demonstrate to any cognizant *competent authority* that:

- (a) the manufacturing methods and materials used are in accordance with the approved *design* specifications; and
- (b) all *packagings* are periodically inspected and, as necessary, repaired and maintained in good condition so that they continue to comply with all relevant requirements and specifications, even after repeated use.

Where *competent authority approval* is required, such *approval* shall take into account and be contingent upon the adequacy of the *quality assurance* programme.

COMPLIANCE ASSURANCE

307. The *competent authority* is responsible for assuring compliance with these Regulations. Means to discharge this responsibility include the establishment and execution of a programme for monitoring the design, manufacture, testing, inspection and maintenance of *packaging*, *special form radioactive material* and *low dispersible radioactive material*, and the preparation, documentation,

GENERAL PROVISIONS

handling and stowage of *packages* by *consignors* and *carriers*, to provide evidence that the provisions of these Regulations are being met in practice.

308. The relevant *competent authority* shall arrange for periodic assessments of the radiation doses to persons due to the transport of *radioactive material*, to ensure that the system of protection and safety complies with the Basic Safety Standards [2].

NON-COMPLIANCE

309. In the event of non-compliance with any limit in these Regulations applicable to *radiation level* or *contamination*:

- (a) the *consignor* shall be informed of the non-compliance by:
 - (i) the *carrier* if the non-compliance is identified during transport; or
 - (ii) the *consignee* if the non-compliance is identified at receipt;
- (b) the *carrier, consignor* or *consignee*, as appropriate, shall:
 - (i) take immediate steps to mitigate the consequences of the non-compliance;
 - (ii) investigate the non-compliance and its causes, circumstances and consequences;
 - (iii) take appropriate action to remedy the causes and circumstances that led to the non-compliance and to prevent a recurrence of circumstances similar to those that led to the non-compliance; and
 - (iv) communicate to the relevant *competent authority(ies)* on the causes of the non-compliance and on corrective or preventive actions taken or to be taken; and
- (c) the communication of the non-compliance to the *consignor* and relevant *competent authority(ies)*, respectively, shall be made as soon as practicable and it shall be immediate whenever an emergency exposure situation has developed or is developing.

SPECIAL ARRANGEMENT

310. *Consignments* for which conformity with the other provisions of these Regulations is impracticable shall not be transported except under *special arrangement*. Provided the *competent authority* is satisfied that conformity with the other provisions of these Regulations is impracticable and that the requisite standards of safety established by these Regulations have been demonstrated

SECTION III

through means alternative to the other provisions, the *competent authority* may approve *special arrangement* transport operations for single or a planned series of multiple *consignments*. The overall level of safety in transport shall be at least equivalent to that which would be provided if all the applicable requirements had been met. For *consignments* of this type, *multilateral approval* shall be required.

TRAINING

311. Workers shall receive appropriate training concerning radiation protection including the precautions to be observed in order to restrict their occupational exposure and the exposure of other persons who might be affected by their actions.

312. Persons engaged in the transport of *radioactive material* shall receive training in the contents of these Regulations commensurate with their responsibilities.

313. Individuals such as those who classify *radioactive material*; pack *radioactive material*; mark and label *radioactive material*; prepare transport documents for *radioactive material*; offer or accept *radioactive material* for transport; carry or handle *radioactive material* in transport; mark or placard or load or unload packages of *radioactive material* into or from transport *vehicles*, bulk *packagings* or *freight containers*; or are otherwise directly involved in the transport of *radioactive material* as determined by the *competent authority*; shall receive the following training:

- (a) General awareness/familiarization training:
 - (i) Each person shall receive training designed to provide familiarity with the general provisions of these Regulations;
 - (ii) Such training shall include a description of the categories of *radioactive material*; labelling, marking, placarding and *packaging* and segregation requirements; a description of the purpose and content of the *radioactive material* transport document; and a description of available emergency response documents;
- (b) Function specific training: Each person shall receive detailed training concerning specific *radioactive material* transport requirements which are applicable to the function that person performs;

GENERAL PROVISIONS

- (c) Safety training: Commensurate with the risk of exposure in the event of a release and the functions performed, each person shall receive training on:
- (i) Methods and procedures for accident avoidance, such as proper use of package handling equipment and appropriate methods of stowage of *radioactive material*;
 - (ii) Available emergency response information and how to use it;
 - (iii) General dangers presented by the various categories of *radioactive material* and how to prevent exposure to those hazards, including if appropriate the use of personal protective clothing and equipment; and
 - (iv) Immediate procedures to be followed in the event of an unintentional release of *radioactive material*, including any emergency response procedures for which the person is responsible and personal protection procedures to be followed.

314. The training required in para. 313 shall be provided or verified upon employment in a position involving *radioactive material* transport and shall be periodically supplemented with retraining as deemed appropriate by the *competent authority*.

Section IV

ACTIVITY LIMITS AND MATERIAL RESTRICTIONS

BASIC RADIONUCLIDE VALUES

401. The following basic values for individual radionuclides are given in Table 1:

- (a) A_1 and A_2 in TBq;
- (b) activity concentration for exempt material in Bq/g; and
- (c) activity limits for exempt consignments in Bq.

DETERMINATION OF BASIC RADIONUCLIDE VALUES

402. For individual radionuclides which are not listed in Table 1 the determination of the basic radionuclide values referred to in para. 401 shall require *multilateral approval*. It is permissible to use an A_2 value calculated using a dose coefficient for the appropriate lung absorption type, as recommended by the International Commission on Radiological Protection, if the chemical forms of each radionuclide under both normal and accident conditions of transport are taken into consideration. Alternatively, the radionuclide values in Table 2 may be used without obtaining *competent authority* approval.

403. In the calculations of A_1 and A_2 for a radionuclide not in Table 1, a single radioactive decay chain in which the radionuclides are present in their naturally occurring proportions, and in which no daughter nuclide has a half-life either longer than 10 days or longer than that of the parent nuclide, shall be considered as a single radionuclide; and the activity to be taken into account and the A_1 or A_2 value to be applied shall be those corresponding to the parent nuclide of that chain. In the case of radioactive decay chains in which any daughter nuclide has a half-life either longer than 10 days or greater than that of the parent nuclide, the parent and such daughter nuclides shall be considered as mixtures of different nuclides.

Text continued on p. 44

SECTION IV

TABLE 1. BASIC RADIONUCLIDE VALUES

Radionuclide (atomic number)	A_1	A_2	Activity concentration for exempt material	Activity limit for an exempt consignment
	(TBq)	(TBq)	(Bq/g)	(Bq)
Actinium (89)				
Ac-225 (a)	8×10^{-1}	6×10^{-3}	1×10^1	1×10^4
Ac-227 (a)	9×10^{-1}	9×10^{-5}	1×10^{-1}	1×10^3
Ac-228	6×10^{-1}	5×10^{-1}	1×10^1	1×10^6
Silver (47)				
Ag-105	2×10^0	2×10^0	1×10^2	1×10^6
Ag-108m (a)	7×10^{-1}	7×10^{-1}	1×10^1 (b)	1×10^6 (b)
Ag-110m (a)	4×10^{-1}	4×10^{-1}	1×10^1	1×10^6
Ag-111	2×10^0	6×10^{-1}	1×10^3	1×10^6
Aluminium (13)				
Al-26	1×10^{-1}	1×10^{-1}	1×10^1	1×10^5
Americium (95)				
Am-241	1×10^1	1×10^{-3}	1×10^0	1×10^4
Am-242m (a)	1×10^1	1×10^{-3}	1×10^0 (b)	1×10^4 (b)
Am-243 (a)	5×10^0	1×10^{-3}	1×10^0 (b)	1×10^3 (b)
Argon (18)				
Ar-37	4×10^1	4×10^1	1×10^6	1×10^8
Ar-39	4×10^1	2×10^1	1×10^7	1×10^4
Ar-41	3×10^{-1}	3×10^{-1}	1×10^2	1×10^9
Arsenic (33)				
As-72	3×10^{-1}	3×10^{-1}	1×10^1	1×10^5
As-73	4×10^1	4×10^1	1×10^3	1×10^7
As-74	1×10^0	9×10^{-1}	1×10^1	1×10^6
As-76	3×10^{-1}	3×10^{-1}	1×10^2	1×10^5
As-77	2×10^1	7×10^{-1}	1×10^3	1×10^6
Astatine (85)				
At-211 (a)	2×10^1	5×10^{-1}	1×10^3	1×10^7

ACTIVITY LIMITS AND MATERIAL RESTRICTIONS

TABLE 1. BASIC RADIONUCLIDE VALUES (cont.)

Radionuclide (atomic number)	A_1	A_2	Activity concentration for exempt material	Activity limit for an exempt consignment
	(TBq)	(TBq)	(Bq/g)	(Bq)
Gold (79)				
Au-193	7×10^0	2×10^0	1×10^2	1×10^7
Au-194	1×10^0	1×10^0	1×10^1	1×10^6
Au-195	1×10^1	6×10^0	1×10^2	1×10^7
Au-198	1×10^0	6×10^{-1}	1×10^2	1×10^6
Au-199	1×10^1	6×10^{-1}	1×10^2	1×10^6
Barium (56)				
Ba-131 (a)	2×10^0	2×10^0	1×10^2	1×10^6
Ba-133	3×10^0	3×10^0	1×10^2	1×10^6
Ba-133m	2×10^1	6×10^{-1}	1×10^2	1×10^6
Ba-140 (a)	5×10^{-1}	3×10^{-1}	1×10^1 (b)	1×10^5 (b)
Beryllium (4)				
Be-7	2×10^1	2×10^1	1×10^3	1×10^7
Be-10	4×10^1	6×10^{-1}	1×10^4	1×10^6
Bismuth (83)				
Bi-205	7×10^{-1}	7×10^{-1}	1×10^1	1×10^6
Bi-206	3×10^{-1}	3×10^{-1}	1×10^1	1×10^5
Bi-207	7×10^{-1}	7×10^{-1}	1×10^1	1×10^6
Bi-210	1×10^0	6×10^{-1}	1×10^3	1×10^6
Bi-210m (a)	6×10^{-1}	2×10^{-2}	1×10^1	1×10^5
Bi-212 (a)	7×10^{-1}	6×10^{-1}	1×10^1 (b)	1×10^5 (b)
Berkelium (97)				
Bk-247	8×10^0	8×10^{-4}	1×10^0	1×10^4
Bk-249 (a)	4×10^1	3×10^{-1}	1×10^3	1×10^6
Bromine (35)				
Br-76	4×10^{-1}	4×10^{-1}	1×10^1	1×10^5
Br-77	3×10^0	3×10^0	1×10^2	1×10^6
Br-82	4×10^{-1}	4×10^{-1}	1×10^1	1×10^6

For footnotes see pp. 41–44.

SECTION IV

TABLE 1. BASIC RADIONUCLIDE VALUES (cont.)

Radionuclide (atomic number)	A_1	A_2	Activity concentration for exempt material	Activity limit for an exempt consignment
	(TBq)	(TBq)	(Bq/g)	(Bq)
Carbon (6)				
C-11	1×10^0	6×10^{-1}	1×10^1	1×10^6
C-14	4×10^1	3×10^0	1×10^4	1×10^7
Calcium (20)				
Ca-41	Unlimited	Unlimited	1×10^5	1×10^7
Ca-45	4×10^1	1×10^0	1×10^4	1×10^7
Ca-47 (a)	3×10^0	3×10^{-1}	1×10^1	1×10^6
Cadmium (48)				
Cd-109	3×10^1	2×10^0	1×10^4	1×10^6
Cd-113m	4×10^1	5×10^{-1}	1×10^3	1×10^6
Cd-115 (a)	3×10^0	4×10^{-1}	1×10^2	1×10^6
Cd-115m	5×10^{-1}	5×10^{-1}	1×10^3	1×10^6
Cerium (58)				
Ce-139	7×10^0	2×10^0	1×10^2	1×10^6
Ce-141	2×10^1	6×10^{-1}	1×10^2	1×10^7
Ce-143	9×10^{-1}	6×10^{-1}	1×10^2	1×10^6
Ce-144 (a)	2×10^{-1}	2×10^{-1}	1×10^2 (b)	1×10^5 (b)
Californium (98)				
Cf-248	4×10^1	6×10^{-3}	1×10^1	1×10^4
Cf-249	3×10^0	8×10^{-4}	1×10^0	1×10^3
Cf-250	2×10^1	2×10^{-3}	1×10^1	1×10^4
Cf-251	7×10^0	7×10^{-4}	1×10^0	1×10^3
Cf-252	1×10^{-1}	3×10^{-3}	1×10^1	1×10^4
Cf-253 (a)	4×10^1	4×10^{-2}	1×10^2	1×10^5
Cf-254	1×10^{-3}	1×10^{-3}	1×10^0	1×10^3
Chlorine (17)				
Cl-36	1×10^1	6×10^{-1}	1×10^4	1×10^6
Cl-38	2×10^{-1}	2×10^{-1}	1×10^1	1×10^5

ACTIVITY LIMITS AND MATERIAL RESTRICTIONS

TABLE 1. BASIC RADIONUCLIDE VALUES (cont.)

Radionuclide (atomic number)	A_1	A_2	Activity concentration for exempt material	Activity limit for an exempt consignment
	(TBq)	(TBq)	(Bq/g)	(Bq)
Curium (96)				
Cm-240	4×10^1	2×10^{-2}	1×10^2	1×10^5
Cm-241	2×10^0	1×10^0	1×10^2	1×10^6
Cm-242	4×10^1	1×10^{-2}	1×10^2	1×10^5
Cm-243	9×10^0	1×10^{-3}	1×10^0	1×10^4
Cm-244	2×10^1	2×10^{-3}	1×10^1	1×10^4
Cm-245	9×10^0	9×10^{-4}	1×10^0	1×10^3
Cm-246	9×10^0	9×10^{-4}	1×10^0	1×10^3
Cm-247 (a)	3×10^0	1×10^{-3}	1×10^0	1×10^4
Cm-248	2×10^{-2}	3×10^{-4}	1×10^0	1×10^3
Cobalt (27)				
Co-55	5×10^{-1}	5×10^{-1}	1×10^1	1×10^6
Co-56	3×10^{-1}	3×10^{-1}	1×10^1	1×10^5
Co-57	1×10^1	1×10^1	1×10^2	1×10^6
Co-58	1×10^0	1×10^0	1×10^1	1×10^6
Co-58m	4×10^1	4×10^1	1×10^4	1×10^7
Co-60	4×10^{-1}	4×10^{-1}	1×10^1	1×10^5
Chromium (24)				
Cr-51	3×10^1	3×10^1	1×10^3	1×10^7
Caesium (55)				
Cs-129	4×10^0	4×10^0	1×10^2	1×10^5
Cs-131	3×10^1	3×10^1	1×10^3	1×10^6
Cs-132	1×10^0	1×10^0	1×10^1	1×10^5
Cs-134	7×10^{-1}	7×10^{-1}	1×10^1	1×10^4
Cs-134m	4×10^1	6×10^{-1}	1×10^3	1×10^5
Cs-135	4×10^1	1×10^0	1×10^4	1×10^7
Cs-136	5×10^{-1}	5×10^{-1}	1×10^1	1×10^5
Cs-137 (a)	2×10^0	6×10^{-1}	1×10^1 (b)	1×10^4 (b)

For footnotes see pp. 41–44.

SECTION IV

TABLE 1. BASIC RADIONUCLIDE VALUES (cont.)

Radionuclide (atomic number)	A_1	A_2	Activity concentration for exempt material	Activity limit for an exempt consignment
	(TBq)	(TBq)	(Bq/g)	(Bq)
Copper (29)				
Cu-64	6×10^0	1×10^0	1×10^2	1×10^6
Cu-67	1×10^1	7×10^{-1}	1×10^2	1×10^6
Dysprosium (66)				
Dy-159	2×10^1	2×10^1	1×10^3	1×10^7
Dy-165	9×10^{-1}	6×10^{-1}	1×10^3	1×10^6
Dy-166 (a)	9×10^{-1}	3×10^{-1}	1×10^3	1×10^6
Erbium (68)				
Er-169	4×10^1	1×10^0	1×10^4	1×10^7
Er-171	8×10^{-1}	5×10^{-1}	1×10^2	1×10^6
Europium (63)				
Eu-147	2×10^0	2×10^0	1×10^2	1×10^6
Eu-148	5×10^{-1}	5×10^{-1}	1×10^1	1×10^6
Eu-149	2×10^1	2×10^1	1×10^2	1×10^7
Eu-150 (short lived)	2×10^0	7×10^{-1}	1×10^3	1×10^6
Eu-150 (long lived)	7×10^{-1}	7×10^{-1}	1×10^1	1×10^6
Eu-152	1×10^0	1×10^0	1×10^1	1×10^6
Eu-152m	8×10^{-1}	8×10^{-1}	1×10^2	1×10^6
Eu-154	9×10^{-1}	6×10^{-1}	1×10^1	1×10^6
Eu-155	2×10^1	3×10^0	1×10^2	1×10^7
Eu-156	7×10^{-1}	7×10^{-1}	1×10^1	1×10^6
Fluorine (9)				
F-18	1×10^0	6×10^{-1}	1×10^1	1×10^6
Iron (26)				
Fe-52 (a)	3×10^{-1}	3×10^{-1}	1×10^1	1×10^6
Fe-55	4×10^1	4×10^1	1×10^4	1×10^6
Fe-59	9×10^{-1}	9×10^{-1}	1×10^1	1×10^6
Fe-60 (a)	4×10^1	2×10^{-1}	1×10^2	1×10^5

ACTIVITY LIMITS AND MATERIAL RESTRICTIONS

TABLE 1. BASIC RADIONUCLIDE VALUES (cont.)

Radionuclide (atomic number)	A_1	A_2	Activity concentration for exempt material	Activity limit for an exempt consignment
	(TBq)	(TBq)	(Bq/g)	(Bq)
Gallium (31)				
Ga-67	7×10^0	3×10^0	1×10^2	1×10^6
Ga-68	5×10^{-1}	5×10^{-1}	1×10^1	1×10^5
Ga-72	4×10^{-1}	4×10^{-1}	1×10^1	1×10^5
Gadolinium (64)				
Gd-146 (a)	5×10^{-1}	5×10^{-1}	1×10^1	1×10^6
Gd-148	2×10^1	2×10^{-3}	1×10^1	1×10^4
Gd-153	1×10^1	9×10^0	1×10^2	1×10^7
Gd-159	3×10^0	6×10^{-1}	1×10^3	1×10^6
Germanium (32)				
Ge-68 (a)	5×10^{-1}	5×10^{-1}	1×10^1	1×10^5
Ge-71	4×10^1	4×10^1	1×10^4	1×10^8
Ge-77	3×10^{-1}	3×10^{-1}	1×10^1	1×10^5
Hafnium (72)				
Hf-172 (a)	6×10^{-1}	6×10^{-1}	1×10^1	1×10^6
Hf-175	3×10^0	3×10^0	1×10^2	1×10^6
Hf-181	2×10^0	5×10^{-1}	1×10^1	1×10^6
Hf-182	Unlimited	Unlimited	1×10^2	1×10^6
Mercury (80)				
Hg-194 (a)	1×10^0	1×10^0	1×10^1	1×10^6
Hg-195m (a)	3×10^0	7×10^{-1}	1×10^2	1×10^6
Hg-197	2×10^1	1×10^1	1×10^2	1×10^7
Hg-197m	1×10^1	4×10^{-1}	1×10^2	1×10^6
Hg-203	5×10^0	1×10^0	1×10^2	1×10^5
Holmium (67)				
Ho-166	4×10^{-1}	4×10^{-1}	1×10^3	1×10^5
Ho-166m	6×10^{-1}	5×10^{-1}	1×10^1	1×10^6

For footnotes see pp. 41–44.

SECTION IV

TABLE 1. BASIC RADIONUCLIDE VALUES (cont.)

Radionuclide (atomic number)	A_1	A_2	Activity concentration for exempt material	Activity limit for an exempt consignment
	(TBq)	(TBq)	(Bq/g)	(Bq)
Iodine (53)				
I-123	6×10^0	3×10^0	1×10^2	1×10^7
I-124	1×10^0	1×10^0	1×10^1	1×10^6
I-125	2×10^1	3×10^0	1×10^3	1×10^6
I-126	2×10^0	1×10^0	1×10^2	1×10^6
I-129	Unlimited	Unlimited	1×10^2	1×10^5
I-131	3×10^0	7×10^{-1}	1×10^2	1×10^6
I-132	4×10^{-1}	4×10^{-1}	1×10^1	1×10^5
I-133	7×10^{-1}	6×10^{-1}	1×10^1	1×10^6
I-134	3×10^{-1}	3×10^{-1}	1×10^1	1×10^5
I-135 (a)	6×10^{-1}	6×10^{-1}	1×10^1	1×10^6
Indium (49)				
In-111	3×10^0	3×10^0	1×10^2	1×10^6
In-113m	4×10^0	2×10^0	1×10^2	1×10^6
In-114m (a)	1×10^1	5×10^{-1}	1×10^2	1×10^6
In-115m	7×10^0	1×10^0	1×10^2	1×10^6
Iridium (77)				
Ir-189 (a)	1×10^1	1×10^1	1×10^2	1×10^7
Ir-190	7×10^{-1}	7×10^{-1}	1×10^1	1×10^6
Ir-192	1×10^0 (c)	6×10^{-1}	1×10^1	1×10^4
Ir-194	3×10^{-1}	3×10^{-1}	1×10^2	1×10^5
Potassium (19)				
K-40	9×10^{-1}	9×10^{-1}	1×10^2	1×10^6
K-42	2×10^{-1}	2×10^{-1}	1×10^2	1×10^6
K-43	7×10^{-1}	6×10^{-1}	1×10^1	1×10^6
Krypton (36)				
Kr-81	4×10^1	4×10^1	1×10^4	1×10^7
Kr-85	1×10^1	1×10^1	1×10^5	1×10^4

ACTIVITY LIMITS AND MATERIAL RESTRICTIONS

TABLE 1. BASIC RADIONUCLIDE VALUES (cont.)

Radionuclide (atomic number)	A_1	A_2	Activity concentration for exempt material	Activity limit for an exempt consignment
	(TBq)	(TBq)	(Bq/g)	(Bq)
Kr-85m	8×10^0	3×10^0	1×10^3	1×10^{10}
Kr-87	2×10^{-1}	2×10^{-1}	1×10^2	1×10^9
Lanthanum (57)				
La-137	3×10^1	6×10^0	1×10^3	1×10^7
La-140	4×10^{-1}	4×10^{-1}	1×10^1	1×10^5
Lutetium (71)				
Lu-172	6×10^{-1}	6×10^{-1}	1×10^1	1×10^6
Lu-173	8×10^0	8×10^0	1×10^2	1×10^7
Lu-174	9×10^0	9×10^0	1×10^2	1×10^7
Lu-174m	2×10^1	1×10^1	1×10^2	1×10^7
Lu-177	3×10^1	7×10^{-1}	1×10^3	1×10^7
Magnesium (12)				
Mg-28 (a)	3×10^{-1}	3×10^{-1}	1×10^1	1×10^5
Manganese (25)				
Mn-52	3×10^{-1}	3×10^{-1}	1×10^1	1×10^5
Mn-53	Unlimited	Unlimited	1×10^4	1×10^9
Mn-54	1×10^0	1×10^0	1×10^1	1×10^6
Mn-56	3×10^{-1}	3×10^{-1}	1×10^1	1×10^5
Molybdenum (42)				
Mo-93	4×10^1	2×10^1	1×10^3	1×10^8
Mo-99 (a)	1×10^0	6×10^{-1}	1×10^2	1×10^6
Nitrogen (7)				
N-13	9×10^{-1}	6×10^{-1}	1×10^2	1×10^9
Sodium (11)				
Na-22	5×10^{-1}	5×10^{-1}	1×10^1	1×10^6
Na-24	2×10^{-1}	2×10^{-1}	1×10^1	1×10^5
Niobium (41)				
Nb-93m	4×10^1	3×10^1	1×10^4	1×10^7

For footnotes see pp. 41–44.

SECTION IV

TABLE 1. BASIC RADIONUCLIDE VALUES (cont.)

Radionuclide (atomic number)	A_1	A_2	Activity concentration for exempt material	Activity limit for an exempt consignment
	(TBq)	(TBq)	(Bq/g)	(Bq)
Nb-94	7×10^{-1}	7×10^{-1}	1×10^1	1×10^6
Nb-95	1×10^0	1×10^0	1×10^1	1×10^6
Nb-97	9×10^{-1}	6×10^{-1}	1×10^1	1×10^6
Neodymium (60)				
Nd-147	6×10^0	6×10^{-1}	1×10^2	1×10^6
Nd-149	6×10^{-1}	5×10^{-1}	1×10^2	1×10^6
Nickel (28)				
Ni-59	Unlimited	Unlimited	1×10^4	1×10^8
Ni-63	4×10^1	3×10^1	1×10^5	1×10^8
Ni-65	4×10^{-1}	4×10^{-1}	1×10^1	1×10^6
Neptunium (93)				
Np-235	4×10^1	4×10^1	1×10^3	1×10^7
Np-236 (short lived)	2×10^1	2×10^0	1×10^3	1×10^7
Np-236 (long lived)	9×10^0	2×10^{-2}	1×10^2	1×10^5
Np-237	2×10^1	2×10^{-3}	1×10^0 (b)	1×10^3 (b)
Np-239	7×10^0	4×10^{-1}	1×10^2	1×10^7
Osmium (76)				
Os-185	1×10^0	1×10^0	1×10^1	1×10^6
Os-191	1×10^1	2×10^0	1×10^2	1×10^7
Os-191m	4×10^1	3×10^1	1×10^3	1×10^7
Os-193	2×10^0	6×10^{-1}	1×10^2	1×10^6
Os-194 (a)	3×10^{-1}	3×10^{-1}	1×10^2	1×10^5
Phosphorus (15)				
P-32	5×10^{-1}	5×10^{-1}	1×10^3	1×10^5
P-33	4×10^1	1×10^0	1×10^5	1×10^8
Protactinium (91)				
Pa-230 (a)	2×10^0	7×10^{-2}	1×10^1	1×10^6
Pa-231	4×10^0	4×10^{-4}	1×10^0	1×10^3

ACTIVITY LIMITS AND MATERIAL RESTRICTIONS

TABLE 1. BASIC RADIONUCLIDE VALUES (cont.)

Radionuclide (atomic number)	A_1	A_2	Activity concentration for exempt material	Activity limit for an exempt consignment
	(TBq)	(TBq)	(Bq/g)	(Bq)
Pa-233	5×10^0	7×10^{-1}	1×10^2	1×10^7
Lead (82)				
Pb-201	1×10^0	1×10^0	1×10^1	1×10^6
Pb-202	4×10^1	2×10^1	1×10^3	1×10^6
Pb-203	4×10^0	3×10^0	1×10^2	1×10^6
Pb-205	Unlimited	Unlimited	1×10^4	1×10^7
Pb-210 (a)	1×10^0	5×10^{-2}	1×10^1 (b)	1×10^4 (b)
Pb-212 (a)	7×10^{-1}	2×10^{-1}	1×10^1 (b)	1×10^5 (b)
Palladium (46)				
Pd-103 (a)	4×10^1	4×10^1	1×10^3	1×10^8
Pd-107	Unlimited	Unlimited	1×10^5	1×10^8
Pd-109	2×10^0	5×10^{-1}	1×10^3	1×10^6
Promethium (61)				
Pm-143	3×10^0	3×10^0	1×10^2	1×10^6
Pm-144	7×10^{-1}	7×10^{-1}	1×10^1	1×10^6
Pm-145	3×10^1	1×10^1	1×10^3	1×10^7
Pm-147	4×10^1	2×10^0	1×10^4	1×10^7
Pm-148m (a)	8×10^{-1}	7×10^{-1}	1×10^1	1×10^6
Pm-149	2×10^0	6×10^{-1}	1×10^3	1×10^6
Pm-151	2×10^0	6×10^{-1}	1×10^2	1×10^6
Polonium (84)				
Po-210	4×10^1	2×10^{-2}	1×10^1	1×10^4
Praseodymium (59)				
Pr-142	4×10^{-1}	4×10^{-1}	1×10^2	1×10^5
Pr-143	3×10^0	6×10^{-1}	1×10^4	1×10^6
Platinum (78)				
Pt-188 (a)	1×10^0	8×10^{-1}	1×10^1	1×10^6
Pt-191	4×10^0	3×10^0	1×10^2	1×10^6

For footnotes see pp. 41–44.

SECTION IV

TABLE 1. BASIC RADIONUCLIDE VALUES (cont.)

Radionuclide (atomic number)	A_1	A_2	Activity concentration for exempt material	Activity limit for an exempt consignment
	(TBq)	(TBq)	(Bq/g)	(Bq)
Pt-193	4×10^1	4×10^1	1×10^4	1×10^7
Pt-193m	4×10^1	5×10^{-1}	1×10^3	1×10^7
Pt-195m	1×10^1	5×10^{-1}	1×10^2	1×10^6
Pt-197	2×10^1	6×10^{-1}	1×10^3	1×10^6
Pt-197m	1×10^1	6×10^{-1}	1×10^2	1×10^6
Plutonium (94)				
Pu-236	3×10^1	3×10^{-3}	1×10^1	1×10^4
Pu-237	2×10^1	2×10^1	1×10^3	1×10^7
Pu-238	1×10^1	1×10^{-3}	1×10^0	1×10^4
Pu-239	1×10^1	1×10^{-3}	1×10^0	1×10^4
Pu-240	1×10^1	1×10^{-3}	1×10^0	1×10^3
Pu-241 (a)	4×10^1	6×10^{-2}	1×10^2	1×10^5
Pu-242	1×10^1	1×10^{-3}	1×10^0	1×10^4
Pu-244 (a)	4×10^{-1}	1×10^{-3}	1×10^0	1×10^4
Radium (88)				
Ra-223 (a)	4×10^{-1}	7×10^{-3}	1×10^2 (b)	1×10^5 (b)
Ra-224 (a)	4×10^{-1}	2×10^{-2}	1×10^1 (b)	1×10^5 (b)
Ra-225 (a)	2×10^{-1}	4×10^{-3}	1×10^2	1×10^5
Ra-226 (a)	2×10^{-1}	3×10^{-3}	1×10^1 (b)	1×10^4 (b)
Ra-228 (a)	6×10^{-1}	2×10^{-2}	1×10^1 (b)	1×10^5 (b)
Rubidium (37)				
Rb-81	2×10^0	8×10^{-1}	1×10^1	1×10^6
Rb-83 (a)	2×10^0	2×10^0	1×10^2	1×10^6
Rb-84	1×10^0	1×10^0	1×10^1	1×10^6
Rb-86	5×10^{-1}	5×10^{-1}	1×10^2	1×10^5
Rb-87	Unlimited	Unlimited	1×10^4	1×10^7
Rb (nat)	Unlimited	Unlimited	1×10^4	1×10^7

ACTIVITY LIMITS AND MATERIAL RESTRICTIONS

TABLE 1. BASIC RADIONUCLIDE VALUES (cont.)

Radionuclide (atomic number)	A_1	A_2	Activity concentration for exempt material	Activity limit for an exempt consignment
	(TBq)	(TBq)	(Bq/g)	(Bq)
Rhenium (75)				
Re-184	1×10^0	1×10^0	1×10^1	1×10^6
Re-184m	3×10^0	1×10^0	1×10^2	1×10^6
Re-186	2×10^0	6×10^{-1}	1×10^3	1×10^6
Re-187	Unlimited	Unlimited	1×10^6	1×10^9
Re-188	4×10^{-1}	4×10^{-1}	1×10^2	1×10^5
Re-189 (a)	3×10^0	6×10^{-1}	1×10^2	1×10^6
Re (nat)	Unlimited	Unlimited	1×10^6	1×10^9
Rhodium (45)				
Rh-99	2×10^0	2×10^0	1×10^1	1×10^6
Rh-101	4×10^0	3×10^0	1×10^2	1×10^7
Rh-102	5×10^{-1}	5×10^{-1}	1×10^1	1×10^6
Rh-102m	2×10^0	2×10^0	1×10^2	1×10^6
Rh-103m	4×10^1	4×10^1	1×10^4	1×10^8
Rh-105	1×10^1	8×10^{-1}	1×10^2	1×10^7
Radon (86)				
Rn-222 (a)	3×10^{-1}	4×10^{-3}	1×10^1 (b)	1×10^8 (b)
Ruthenium (44)				
Ru-97	5×10^0	5×10^0	1×10^2	1×10^7
Ru-103 (a)	2×10^0	2×10^0	1×10^2	1×10^6
Ru-105	1×10^0	6×10^{-1}	1×10^1	1×10^6
Ru-106 (a)	2×10^{-1}	2×10^{-1}	1×10^2 (b)	1×10^5 (b)
Sulphur (16)				
S-35	4×10^1	3×10^0	1×10^5	1×10^8
Antimony (51)				
Sb-122	4×10^{-1}	4×10^{-1}	1×10^2	1×10^4
Sb-124	6×10^{-1}	6×10^{-1}	1×10^1	1×10^6
Sb-125	2×10^0	1×10^0	1×10^2	1×10^6

For footnotes see pp. 41–44.

SECTION IV

TABLE 1. BASIC RADIONUCLIDE VALUES (cont.)

Radionuclide (atomic number)	A_1	A_2	Activity concentration for exempt material	Activity limit for an exempt consignment
	(TBq)	(TBq)	(Bq/g)	(Bq)
Sb-126	4×10^{-1}	4×10^{-1}	1×10^1	1×10^5
Scandium (21)				
Sc-44	5×10^{-1}	5×10^{-1}	1×10^1	1×10^5
Sc-46	5×10^{-1}	5×10^{-1}	1×10^1	1×10^6
Sc-47	1×10^1	7×10^{-1}	1×10^2	1×10^6
Sc-48	3×10^{-1}	3×10^{-1}	1×10^1	1×10^5
Selenium (34)				
Se-75	3×10^0	3×10^0	1×10^2	1×10^6
Se-79	4×10^1	2×10^0	1×10^4	1×10^7
Silicon (14)				
Si-31	6×10^{-1}	6×10^{-1}	1×10^3	1×10^6
Si-32	4×10^1	5×10^{-1}	1×10^3	1×10^6
Samarium (62)				
Sm-145	1×10^1	1×10^1	1×10^2	1×10^7
Sm-147	Unlimited	Unlimited	1×10^1	1×10^4
Sm-151	4×10^1	1×10^1	1×10^4	1×10^8
Sm-153	9×10^0	6×10^{-1}	1×10^2	1×10^6
Tin (50)				
Sn-113 (a)	4×10^0	2×10^0	1×10^3	1×10^7
Sn-117m	7×10^0	4×10^{-1}	1×10^2	1×10^6
Sn-119m	4×10^1	3×10^1	1×10^3	1×10^7
Sn-121m (a)	4×10^1	9×10^{-1}	1×10^3	1×10^7
Sn-123	8×10^{-1}	6×10^{-1}	1×10^3	1×10^6
Sn-125	4×10^{-1}	4×10^{-1}	1×10^2	1×10^5
Sn-126 (a)	6×10^{-1}	4×10^{-1}	1×10^1	1×10^5
Strontium (38)				
Sr-82 (a)	2×10^{-1}	2×10^{-1}	1×10^1	1×10^5
Sr-85	2×10^0	2×10^0	1×10^2	1×10^6

ACTIVITY LIMITS AND MATERIAL RESTRICTIONS

TABLE 1. BASIC RADIONUCLIDE VALUES (cont.)

Radionuclide (atomic number)	A_1	A_2	Activity concentration for exempt material	Activity limit for an exempt consignment
	(TBq)	(TBq)	(Bq/g)	(Bq)
Sr-85m	5×10^0	5×10^0	1×10^2	1×10^7
Sr-87m	3×10^0	3×10^0	1×10^2	1×10^6
Sr-89	6×10^{-1}	6×10^{-1}	1×10^3	1×10^6
Sr-90 (a)	3×10^{-1}	3×10^{-1}	1×10^2 (b)	1×10^4 (b)
Sr-91 (a)	3×10^{-1}	3×10^{-1}	1×10^1	1×10^5
Sr-92 (a)	1×10^0	3×10^{-1}	1×10^1	1×10^6
Tritium (1)				
T(H-3)	4×10^1	4×10^1	1×10^6	1×10^9
Tantalum (73)				
Ta-178 (long lived)	1×10^0	8×10^{-1}	1×10^1	1×10^6
Ta-179	3×10^1	3×10^1	1×10^3	1×10^7
Ta-182	9×10^{-1}	5×10^{-1}	1×10^1	1×10^4
Terbium (65)				
Tb-157	4×10^1	4×10^1	1×10^4	1×10^7
Tb-158	1×10^0	1×10^0	1×10^1	1×10^6
Tb-160	1×10^0	6×10^{-1}	1×10^1	1×10^6
Technetium (43)				
Tc-95m (a)	2×10^0	2×10^0	1×10^1	1×10^6
Tc-96	4×10^{-1}	4×10^{-1}	1×10^1	1×10^6
Tc-96m (a)	4×10^{-1}	4×10^{-1}	1×10^3	1×10^7
Tc-97	Unlimited	Unlimited	1×10^3	1×10^8
Tc-97m	4×10^1	1×10^0	1×10^3	1×10^7
Tc-98	8×10^{-1}	7×10^{-1}	1×10^1	1×10^6
Tc-99	4×10^1	9×10^{-1}	1×10^4	1×10^7
Tc-99m	1×10^1	4×10^0	1×10^2	1×10^7
Tellurium (52)				
Te-121	2×10^0	2×10^0	1×10^1	1×10^6
Te-121m	5×10^0	3×10^0	1×10^2	1×10^6

For footnotes see pp. 41–44.

SECTION IV

TABLE 1. BASIC RADIONUCLIDE VALUES (cont.)

Radionuclide (atomic number)	A_1	A_2	Activity concentration for exempt material	Activity limit for an exempt consignment
	(TBq)	(TBq)	(Bq/g)	(Bq)
Te-123m	8×10^0	1×10^0	1×10^2	1×10^7
Te-125m	2×10^1	9×10^{-1}	1×10^3	1×10^7
Te-127	2×10^1	7×10^{-1}	1×10^3	1×10^6
Te-127m (a)	2×10^1	5×10^{-1}	1×10^3	1×10^7
Te-129	7×10^{-1}	6×10^{-1}	1×10^2	1×10^6
Te-129m (a)	8×10^{-1}	4×10^{-1}	1×10^3	1×10^6
Te-131m (a)	7×10^{-1}	5×10^{-1}	1×10^1	1×10^6
Te-132 (a)	5×10^{-1}	4×10^{-1}	1×10^2	1×10^7
Thorium (90)				
Th-227	1×10^1	5×10^{-3}	1×10^1	1×10^4
Th-228 (a)	5×10^{-1}	1×10^{-3}	1×10^0 (b)	1×10^4 (b)
Th-229	5×10^0	5×10^{-4}	1×10^0 (b)	1×10^3 (b)
Th-230	1×10^1	1×10^{-3}	1×10^0	1×10^4
Th-231	4×10^1	2×10^{-2}	1×10^3	1×10^7
Th-232	Unlimited	Unlimited	1×10^1	1×10^4
Th-234 (a)	3×10^{-1}	3×10^{-1}	1×10^3 (b)	1×10^5 (b)
Th (nat)	Unlimited	Unlimited	1×10^0 (b)	1×10^3 (b)
Titanium (22)				
Ti-44 (a)	5×10^{-1}	4×10^{-1}	1×10^1	1×10^5
Thallium (81)				
Tl-200	9×10^{-1}	9×10^{-1}	1×10^1	1×10^6
Tl-201	1×10^1	4×10^0	1×10^2	1×10^6
Tl-202	2×10^0	2×10^0	1×10^2	1×10^6
Tl-204	1×10^1	7×10^{-1}	1×10^4	1×10^4
Thulium (69)				
Tm-167	7×10^0	8×10^{-1}	1×10^2	1×10^6
Tm-170	3×10^0	6×10^{-1}	1×10^3	1×10^6
Tm-171	4×10^1	4×10^1	1×10^4	1×10^8

ACTIVITY LIMITS AND MATERIAL RESTRICTIONS

TABLE 1. BASIC RADIONUCLIDE VALUES (cont.)

Radionuclide (atomic number)	A_1	A_2	Activity concentration for exempt material	Activity limit for an exempt consignment
	(TBq)	(TBq)	(Bq/g)	(Bq)
Uranium (92)				
U-230 (fast lung absorption)(a), (d)	4×10^1	1×10^{-1}	1×10^1 (b)	1×10^5 (b)
U-230 (medium lung absorption)(a), (e)	4×10^1	4×10^{-3}	1×10^1	1×10^4
U-230 (slow lung absorption)(a), (f)	3×10^1	3×10^{-3}	1×10^1	1×10^4
U-232 (fast lung absorption)(d)	4×10^1	1×10^{-2}	1×10^0 (b)	1×10^3 (b)
U-232 (medium lung absorption)(e)	4×10^1	7×10^{-3}	1×10^1	1×10^4
U-232 (slow lung absorption)(f)	1×10^1	1×10^{-3}	1×10^1	1×10^4
U-233 (fast lung absorption)(d)	4×10^1	9×10^{-2}	1×10^1	1×10^4
U-233 (medium lung absorption)(e)	4×10^1	2×10^{-2}	1×10^2	1×10^5
U-233 (slow lung absorption)(f)	4×10^1	6×10^{-3}	1×10^1	1×10^5
U-234 (fast lung absorption)(d)	4×10^1	9×10^{-2}	1×10^1	1×10^4
U-234 (medium lung absorption)(e)	4×10^1	2×10^{-2}	1×10^2	1×10^5
U-234 (slow lung absorption)(f)	4×10^1	6×10^{-3}	1×10^1	1×10^5
U-235 (all lung absorption types)(a),(d),(e),(f)	Unlimited	Unlimited	1×10^1 (b)	1×10^4 (b)
U-236 (fast lung absorption)(d)	Unlimited	Unlimited	1×10^1	1×10^4
U-236 (medium lung absorption)(e)	4×10^1	2×10^{-2}	1×10^2	1×10^5

For footnotes see pp. 41–44.

SECTION IV

TABLE 1. BASIC RADIONUCLIDE VALUES (cont.)

Radionuclide (atomic number)	A_1	A_2	Activity concentration for exempt material	Activity limit for an exempt consignment
	(TBq)	(TBq)	(Bq/g)	(Bq)
U-236 (slow lung absorption)(f)	4×10^1	6×10^{-3}	1×10^1	1×10^4
U-238 (all lung absorption types)(d),(e),(f)	Unlimited	Unlimited	1×10^1 (b)	1×10^4 (b)
U (nat)	Unlimited	Unlimited	1×10^0 (b)	1×10^3 (b)
U (enriched to 20% or less)(g)	Unlimited	Unlimited	1×10^0	1×10^3
U (dep)	Unlimited	Unlimited	1×10^0	1×10^3
Vanadium (23)				
V-48	4×10^{-1}	4×10^{-1}	1×10^1	1×10^5
V-49	4×10^1	4×10^1	1×10^4	1×10^7
Tungsten (74)				
W-178 (a)	9×10^0	5×10^0	1×10^1	1×10^6
W-181	3×10^1	3×10^1	1×10^3	1×10^7
W-185	4×10^1	8×10^{-1}	1×10^4	1×10^7
W-187	2×10^0	6×10^{-1}	1×10^2	1×10^6
W-188 (a)	4×10^{-1}	3×10^{-1}	1×10^2	1×10^5
Xenon (54)				
Xe-122 (a)	4×10^{-1}	4×10^{-1}	1×10^2	1×10^9
Xe-123	2×10^0	7×10^{-1}	1×10^2	1×10^9
Xe-127	4×10^0	2×10^0	1×10^3	1×10^5
Xe-131m	4×10^1	4×10^1	1×10^4	1×10^4
Xe-133	2×10^1	1×10^1	1×10^3	1×10^4
Xe-135	3×10^0	2×10^0	1×10^3	1×10^{10}
Yttrium (39)				
Y-87 (a)	1×10^0	1×10^0	1×10^1	1×10^6
Y-88	4×10^{-1}	4×10^{-1}	1×10^1	1×10^6
Y-90	3×10^{-1}	3×10^{-1}	1×10^3	1×10^5

ACTIVITY LIMITS AND MATERIAL RESTRICTIONS

TABLE 1. BASIC RADIONUCLIDE VALUES (cont.)

Radionuclide (atomic number)	A_1	A_2	Activity concentration for exempt material	Activity limit for an exempt consignment
	(TBq)	(TBq)	(Bq/g)	(Bq)
Y-91	6×10^{-1}	6×10^{-1}	1×10^3	1×10^6
Y-91m	2×10^0	2×10^0	1×10^2	1×10^6
Y-92	2×10^{-1}	2×10^{-1}	1×10^2	1×10^5
Y-93	3×10^{-1}	3×10^{-1}	1×10^2	1×10^5
Ytterbium (70)				
Yb-169	4×10^0	1×10^0	1×10^2	1×10^7
Yb-175	3×10^1	9×10^{-1}	1×10^3	1×10^7
Zinc (30)				
Zn-65	2×10^0	2×10^0	1×10^1	1×10^6
Zn-69	3×10^0	6×10^{-1}	1×10^4	1×10^6
Zn-69m (a)	3×10^0	6×10^{-1}	1×10^2	1×10^6
Zirconium (40)				
Zr-88	3×10^0	3×10^0	1×10^2	1×10^6
Zr-93	Unlimited	Unlimited	1×10^3 (b)	1×10^7 (b)
Zr-95 (a)	2×10^0	8×10^{-1}	1×10^1	1×10^6
Zr-97 (a)	4×10^{-1}	4×10^{-1}	1×10^1 (b)	1×10^5 (b)

(a) A_1 and/or A_2 values for these parent radionuclides include contributions from daughter radionuclides with half-lives of less than 10 days, as listed in the following:

Mg-28	Al-28
Ar-42	K-42
Ca-47	Sc-47
Ti-44	Sc-44
Fe-52	Mn-52m
Fe-60	Co-60m
Zn-69m	Zn-69
Ge-68	Ga-68
Rb-83	Kr-83m
Sr-82	Rb-82
Sr-90	Y-90

SECTION IV

Table 1, footnote (a) (cont.)

Sr-91	Y-91m
Sr-92	Y-92
Y-87	Sr-87m
Zr-95	Nb-95m
Zr-97	Nb-97m, Nb-97
Mo-99	Tc-99m
Tc-95m	Tc-95
Tc-96m	Tc-96
Ru-103	Rh-103m
Ru-106	Rh-106
Pd-103	Rh-103m
Ag-108m	Ag-108
Ag-110m	Ag-110
Cd-115	In-115m
In-114m	In-114
Sn-113	In-113m
Sn-121m	Sn-121
Sn-126	Sb-126m
Te-118	Sb-118
Te-127m	Te-127
Te-129m	Te-129
Te-131m	Te-131
Te-132	I-132
I-135	Xe-135m
Xe-122	I-122
Cs-137	Ba-137m
Ba-131	Cs-131
Ba-140	La-140
Ce-144	Pr-144m, Pr-144
Pm-148m	Pm-148
Gd-146	Eu-146
Dy-166	Ho-166
Hf-172	Lu-172
W-178	Ta-178
W-188	Re-188
Re-189	Os-189m
Os-194	Ir-194
Ir-189	Os-189m
Pt-188	Ir-188
Hg-194	Au-194
Hg-195m	Hg-195
Pb-210	Bi-210
Pb-212	Bi-212, Tl-208, Po-212
Bi-210m	Tl-206
Bi-212	Tl-208, Po-212
At-211	Po-211

ACTIVITY LIMITS AND MATERIAL RESTRICTIONS

Table 1, footnote (a) (cont.)

Rn-222	Po-218, Pb-214, At-218, Bi-214, Po-214
Ra-223	Rn-219, Po-215, Pb-211, Bi-211, Po-211, Tl-207
Ra-224	Rn-220, Po-216, Pb-212, Bi-212, Tl-208, Po-212
Ra-225	Ac-225, Fr-221, At-217, Bi-213, Tl-209, Po-213, Pb-209
Ra-226	Rn-222, Po-218, Pb-214, At-218, Bi-214, Po-214
Ra-228	Ac-228
Ac-225	Fr-221, At-217, Bi-213, Tl-209, Po-213, Pb-209
Ac-227	Fr-223
Th-228	Ra-224, Rn-220, Po-216, Pb-212, Bi-212, Tl-208, Po-212
Th-234	Pa-234m, Pa-234
Pa-230	Ac-226, Th-226, Fr-222, Ra-222, Rn-218, Po-214
U-230	Th-226, Ra-222, Rn-218, Po-214
U-235	Th-231
Pu-241	U-237
Pu-244	U-240, Np-240m
Am-242m	Am-242, Np-238
Am-243	Np-239
Cm-247	Pu-243
Bk-249	Am-245
Cf-253	Cm-249

- (b) Parent nuclides and their progeny included in secular equilibrium are listed in the following:

Sr-90	Y-90
Zr-93	Nb-93m
Zr-97	Nb-97
Ru-106	Rh-106
Ag-108m	Ag-108
Cs-137	Ba-137m
Ce-144	Pr-144
Ba-140	La-140
Bi-212	Tl-208 (0.36), Po-212 (0.64)
Pb-210	Bi-210, Po-210
Pb-212	Bi-212, Tl-208 (0.36), Po-212 (0.64)
Rn-222	Po-218, Pb-214, Bi-214, Po-214
Ra-223	Rn-219, Po-215, Pb-211, Bi-211, Tl-207
Ra-224	Rn-220, Po-216, Pb-212, Bi-212, Tl-208 (0.36), Po-212 (0.64)
Ra-226	Rn-222, Po-218, Pb-214, Bi-214, Po-214, Pb-210, Bi-210, Po-210
Ra-228	Ac-228
Th-228	Ra-224, Rn-220, Po-216, Pb-212, Bi-212, Tl-208 (0.36), Po-212 (0.64)
Th-229	Ra-225, Ac-225, Fr-221, At-217, Bi-213, Po-213, Pb-209
Th-nat	Ra-228, Ac-228, Th-228, Ra-224, Rn-220, Po-216, Pb-212, Bi-212, Tl-208 (0.36), Po-212 (0.64)
Th-234	Pa-234m
U-230	Th-226, Ra-222, Rn-218, Po-214

SECTION IV

Table 1, footnote (b) (cont.)

U-232	Th-228, Ra-224, Rn-220, Po-216, Pb-212, Bi-212, Tl-208 (0.36), Po-212 (0.64)
U-235	Th-231
U-238	Th-234, Pa-234m
U-nat	Th-234, Pa-234m, U-234, Th-230, Ra-226, Rn-222, Po-218, Pb-214, Bi-214, Po-214, Pb-210, Bi-210, Po-210
Np-237	Pa-233
Am-242m	Am-242
Am-243	Np-239

- (c) The quantity may be determined from a measurement of the rate of decay or a measurement of the radiation level at a prescribed distance from the source.
- (d) These values apply only to compounds of uranium that take the chemical form of UF_6 , UO_2F_2 and $UO_2(NO_3)_2$ in both normal and accident conditions of transport.
- (e) These values apply only to compounds of uranium that take the chemical form of UO_3 , UF_4 , UCl_4 and hexavalent compounds in both normal and accident conditions of transport.
- (f) These values apply to all compounds of uranium other than those specified in (d) and (e) above.
- (g) These values apply to *unirradiated uranium* only.

404. For mixtures of radionuclides, the determination of the basic radionuclide values referred to in para. 401 may be determined as follows

$$X_m = \frac{1}{\sum_i \frac{f(i)}{X(i)}}$$

where

- f(i) is the fraction of activity or activity concentration of radionuclide i in the mixture;
- X(i) is the appropriate value of A_1 or A_2 , or the activity concentration for exempt material or the activity limit for an exempt *consignment* as appropriate for the radionuclide i; and
- X_m is the derived value of A_1 or A_2 , or the activity concentration for exempt material or the activity limit for an exempt *consignment* in the case of a mixture.

405. When the identity of each radionuclide is known but the individual activities of some of the radionuclides are not known, the radionuclides may be grouped and the lowest radionuclide value, as appropriate, for the

ACTIVITY LIMITS AND MATERIAL RESTRICTIONS

TABLE 2. BASIC RADIONUCLIDE VALUES FOR UNKNOWN RADIONUCLIDES OR MIXTURES

Radioactive contents	A_1	A_2	Activity concentration for exempt material	Activity limit for an exempt consignment
	(TBq)	(TBq)	(Bq/g)	(Bq)
Only beta or gamma emitting nuclides are known to be present	0.1	0.02	1×10^1	1×10^4
Alpha emitting nuclides, but no neutron emitters, are known to be present	0.2	9×10^{-5}	1×10^{-1}	1×10^3
Neutron emitting nuclides are known to be present or no relevant data are available	0.001	9×10^{-5}	1×10^{-1}	1×10^3

radionuclides in each group may be used in applying the formulas in paras 404 and 414. Groups may be based on the total alpha activity and the total beta/gamma activity when these are known, using the lowest radionuclide values for the alpha emitters or beta/gamma emitters, respectively.

406. For individual radionuclides or for mixtures of radionuclides for which relevant data are not available, the values shown in Table 2 shall be used.

CONTENTS LIMITS FOR PACKAGES

407. The quantity of *radioactive material* in a *package* shall not exceed the relevant limits specified in paras 408–419.

Excepted packages

408. For *radioactive material* other than articles manufactured of *natural uranium*, *depleted uranium* or natural thorium, an *excepted package* shall not contain activities greater than the following:

SECTION IV

TABLE 3. ACTIVITY LIMITS FOR EXCEPTED PACKAGES

Physical state of contents	Instrument or article		Materials
	Item limits ^a	Package limits ^a	Package limits ^a
Solids:			
<i>special form</i>	$10^{-2}A_1$	A_1	$10^{-3}A_1$
other forms	$10^{-2}A_2$	A_2	$10^{-3}A_2$
Liquids	$10^{-3}A_2$	$10^{-1}A_2$	$10^{-4}A_2$
Gases			
tritium	$2 \times 10^{-2}A_2$	$2 \times 10^{-1}A_2$	$2 \times 10^{-2}A_2$
<i>special form</i>	$10^{-3}A_1$	$10^{-2}A_1$	$10^{-3}A_1$
other forms	$10^{-3}A_2$	$10^{-2}A_2$	$10^{-3}A_2$

^a For mixtures of radionuclides, see paras 404–406.

- (a) where the *radioactive material* is enclosed in or is included as a component part of an instrument or other manufactured article, such as a clock or electronic apparatus, the limits specified in columns 2 and 3 of Table 3 for each individual item and each *package*, respectively; and
- (b) where the *radioactive material* is not so enclosed in or is not included as a component of an instrument or other manufactured article, the *package* limits specified in column 4 of Table 3.

409. For articles manufactured of *natural uranium*, *depleted uranium* or natural thorium, an *excepted package* may contain any quantity of such material provided that the outer surface of the uranium or thorium is enclosed in an inactive sheath made of metal or some other substantial material.

410. For transport by post, the total activity in each *excepted package* shall not exceed one tenth of the relevant limit specified in Table 3.

Type IP-1, Type IP-2 and Type IP-3

411. The *radioactive contents* in a single *package* of *LSA material* or in a single *package* of *SCO* shall be so restricted that the *radiation level* specified in para. 521 shall not be exceeded, and the activity in a single *package* shall also be so restricted that the activity limits for a *conveyance* specified in para. 525 shall not be exceeded.

ACTIVITY LIMITS AND MATERIAL RESTRICTIONS

412. A single *package* of non-combustible solid *LSA-II* or *LSA-III material*, if carried by air, shall not contain an activity greater than $3000A_2$.

Type A packages

413. *Type A packages* shall not contain activities greater than the following:

- (a) for *special form radioactive material* — A_1 ; or
- (b) for all other *radioactive material* — A_2 .

414. For mixtures of radionuclides whose identities and respective activities are known, the following condition shall apply to the *radioactive contents* of a *Type A package*:

$$\sum_i \frac{B(i)}{A_1(i)} + \sum_j \frac{C(j)}{A_2(j)} \leq 1$$

where

$B(i)$ is the activity of radionuclide i as *special form radioactive material* and $A_1(i)$ is the A_1 value for radionuclide i ; and

$C(j)$ is the activity of radionuclide j as other than *special form radioactive material* and $A_2(j)$ is the A_2 value for radionuclide j .

Type B(U) and Type B(M) packages

415. *Type B(U)* and *Type B(M) packages* shall not contain:

- (a) activities greater than those authorized for the *package design*,
- (b) radionuclides different from those authorized for the *package design*, or
- (c) contents in a form, or a physical or chemical state, different from those authorized for the *package design*,

as specified in their certificates of approval.

416. *Type B(U)* and *Type B(M) packages*, if transported by air, shall meet the requirements of para. 415 and shall not contain activities greater than the following:

- (a) for *low dispersible radioactive material* — as authorized for the *package design* as specified in the certificate of approval,

SECTION IV

- (b) for *special form radioactive material* — $3000A_1$ or $100\,000A_2$, whichever is the lower; or
- (c) for all other *radioactive material* — $3000A_2$.

Type C packages

417. *Type C packages* shall not contain:

- (a) activities greater than those authorized for the *package design*,
- (b) radionuclides different from those authorized for the *package design*, or
- (c) contents in a form, or a physical or chemical state, different from those authorized for the *package design*,

as specified in their certificates of approval.

Packages containing fissile material

418. Unless excepted by para. 672, *packages* containing *fissile material* shall not contain:

- (a) a mass of *fissile material* different from that authorized for the *package design*,
- (b) any radionuclide or *fissile material* different from those authorized for the *package design*, or
- (c) contents in a form or physical or chemical state, or in a spatial arrangement, different from those authorized for the *package design*,

as specified in their certificates of approval where appropriate.

Packages containing uranium hexafluoride

419. *Packages* containing uranium hexafluoride shall not contain:

- (a) a mass of uranium hexafluoride different from that authorized for the *package design*,
- (b) a mass of uranium hexafluoride greater than a value that would lead to an ullage smaller than 5% at the maximum temperature of the *package* as specified for the plant systems where the *package* shall be used, or
- (c) uranium hexafluoride other than in solid form or at an internal pressure above atmospheric pressure when presented for transport.

Section V

REQUIREMENTS AND CONTROLS FOR TRANSPORT

REQUIREMENTS BEFORE THE FIRST SHIPMENT

501. Before the first *shipment* of any *package*, the following requirements shall be fulfilled:

- (a) If the design pressure of the *containment system* exceeds 35 kPa (gauge), it shall be ensured that the *containment system* of each *package* conforms to the approved design requirements relating to the capability of that system to maintain its integrity under that pressure.
- (b) For each *Type B(U)*, *Type B(M)* and *Type C package* and for each *package* containing *fissile material*, it shall be ensured that the effectiveness of its shielding and containment and, where necessary, the heat transfer characteristics and the effectiveness of the *confinement system*, are within the limits applicable to or specified for the approved *design*.
- (c) For *packages* containing *fissile material*, where, in order to comply with the requirements of para. 671, neutron poisons are specifically included as components of the *package*, checks shall be performed to confirm the presence and distribution of those neutron poisons.

REQUIREMENTS BEFORE EACH SHIPMENT

502. Before each *shipment* of any *package*, the following requirements shall be fulfilled:

- (a) For any *package* it shall be ensured that all the requirements specified in the relevant provisions of these Regulations have been satisfied.
- (b) It shall be ensured that lifting attachments which do not meet the requirements of para. 607 have been removed or otherwise rendered incapable of being used for lifting the *package*, in accordance with para. 608.
- (c) For each *package* requiring *competent authority* approval, it shall be ensured that all the requirements specified in the approval certificates have been satisfied.

SECTION V

- (d) Each *Type B(U)*, *Type B(M)* and *Type C package* shall be held until equilibrium conditions have been approached closely enough to demonstrate compliance with the requirements for temperature and pressure unless an exemption from these requirements has received *unilateral approval*.
- (e) For each *Type B(U)*, *Type B(M)* and *Type C package*, it shall be ensured by inspection and/or appropriate tests that all closures, valve and other openings of the *containment system* through which the *radioactive contents* might escape are properly closed and, where appropriate, sealed in the manner for which the demonstrations of compliance with the requirements of paras 657 and 669 were made.
- (f) For each *special form radioactive material*, it shall be ensured that all the requirements specified in the approval certificate and the relevant provisions of these Regulations have been satisfied.
- (g) For *packages* containing *fissile material* the measurement specified in para. 674(b) and the tests to demonstrate closure of each *package* as specified in para. 677 shall be performed where applicable.
- (h) For each *low dispersible radioactive material*, it shall be ensured that all the requirements specified in the approval certificate and the relevant provisions of these Regulations have been satisfied.

TRANSPORT OF OTHER GOODS

503. A *package* shall not contain any items other than those that are necessary for the use of the *radioactive material*. The interaction between these items and the *package*, under the conditions of transport applicable to the *design*, shall not reduce the safety of the *package*.

504. *Tanks* and *intermediate bulk containers* used for the transport of *radioactive material* shall not be used for the storage or transport of other goods unless decontaminated to below the level of 0.4 Bq/cm² for beta and gamma emitters and *low toxicity alpha emitters* and 0.04 Bq/cm² for all other alpha emitters.

505. The transport of other goods with *consignments* being transported under *exclusive use* shall be permitted provided the arrangements are controlled only by the *consignor* and it is not prohibited by other regulations.

506. *Consignments* shall be segregated from other dangerous goods during transport in compliance with the relevant transport regulations for dangerous

REQUIREMENTS AND CONTROLS FOR TRANSPORT

goods of each of the countries through or into which the materials will be transported, and, where applicable, with the regulations of the cognizant transport organizations, as well as these Regulations.

OTHER DANGEROUS PROPERTIES OF CONTENTS

507. In addition to the radioactive and fissile properties, any other dangerous properties of the contents of the *package*, such as explosiveness, flammability, pyrophoricity, chemical toxicity and corrosiveness, shall be taken into account in the packing, labelling, marking, placarding, storage and transport in order to be in compliance with the relevant transport regulations for dangerous goods of each of the countries through or into which the materials will be transported, and, where applicable, with the regulations of the cognizant transport organizations, as well as these Regulations.

REQUIREMENTS AND CONTROLS FOR CONTAMINATION AND FOR LEAKING PACKAGES

508. The *non-fixed contamination* on the external surfaces of any *package* shall be kept as low as practicable and, under routine conditions of transport, shall not exceed the following limits:

- (a) 4 Bq/cm² for beta and gamma emitters and *low toxicity alpha emitters*, and
- (b) 0.4 Bq/cm² for all other alpha emitters.

These limits are applicable when averaged over any area of 300 cm² of any part of the surface.

509. Except as provided in para. 514, the level of *non-fixed contamination* on the external and internal surfaces of *overpacks*, *freight containers*, *tanks*, *intermediate bulk containers* and *conveyances* shall not exceed the limits specified in para. 508.

510. If it is evident that a *package* is damaged or leaking, or if it is suspected that the *package* may have leaked or been damaged, access to the *package* shall be restricted and a qualified person shall, as soon as possible, assess the extent of *contamination* and the resultant *radiation level* of the *package*. The scope of the assessment shall include the *package*, the *conveyance*, the adjacent loading and unloading areas, and, if necessary, all other material which has been carried

SECTION V

in the *conveyance*. When necessary, additional steps for the protection of persons, property and the environment, in accordance with provisions established by the relevant *competent authority*, shall be taken to overcome and minimize the consequences of such leakage or damage.

511. *Packages* which are damaged or leaking *radioactive contents* in excess of allowable limits for normal conditions of transport may be removed to an acceptable interim location under supervision, but shall not be forwarded until repaired or reconditioned and decontaminated.

512. A *conveyance* and equipment used regularly for the transport of *radioactive material* shall be periodically checked to determine the level of *contamination*. The frequency of such checks shall be related to the likelihood of *contamination* and the extent to which *radioactive material* is transported.

513. Except as provided in para. 514, any *conveyance*, or equipment or part thereof which has become contaminated above the limits specified in para. 508 in the course of the transport of *radioactive material*, or which shows a *radiation level* in excess of 5 $\mu\text{Sv/h}$ at the surface, shall be decontaminated as soon as possible by a qualified person and shall not be re-used unless the *non-fixed contamination* does not exceed the limits specified in para. 508 and the *radiation level* resulting from the *fixed contamination* on surfaces after decontamination is less than 5 $\mu\text{Sv/h}$ at the surface.

514. A *freight container, tank, intermediate bulk container* or *conveyance* dedicated to the transport of unpackaged *radioactive material* under *exclusive use* shall be excepted from the requirements of paras 509 and 513 solely with regard to its internal surfaces and only for as long as it remains under that specific *exclusive use*.

REQUIREMENTS AND CONTROLS FOR TRANSPORT OF EXCEPTED PACKAGES

515. *Excepted packages* shall be subject only to the following provisions in Sections V and VI:

- (a) The requirements specified in paras 507, 508, 511, 516, 534–537, 550(c), 555 and, as applicable, 517–520;
- (b) The requirements for *excepted packages* specified in para. 620;

REQUIREMENTS AND CONTROLS FOR TRANSPORT

- (c) If the *excepted package* contains *fissile material*, one of the fissile exceptions provided by para. 672 shall apply and the requirement of para. 634 shall be met; and
- (d) The requirements in paras 580 and 581 if transported by post.

516. The *radiation level* at any point on the external surface of an *excepted package* shall not exceed 5 $\mu\text{Sv/h}$.

517. *Radioactive material* which is enclosed in or is included as a component part of an instrument or other manufactured article, with activity not exceeding the item and *package* limits specified in columns 2 and 3 respectively of Table 3, may be transported in an *excepted package* provided that:

- (a) The *radiation level* at 10 cm from any point on the external surface of any unpackaged instrument or article is not greater than 0.1 mSv/h; and
- (b) Each instrument or article bears the marking “RADIOACTIVE” except:
 - (i) radioluminescent timepieces or devices,
 - (ii) consumer products that either have received regulatory approval according to para. 107(d) or do not individually exceed the activity limit for an exempt *consignment* in Table 1 (column 5), provided such products are transported in a *package* that bears the marking “RADIOACTIVE” on an internal surface in such a manner that warning of the presence of *radioactive material* is visible on opening the *package*, and
- (c) The active material is completely enclosed by non-active components (a device performing the sole function of containing *radioactive material* shall not be considered to be an instrument or manufactured article).

518. *Radioactive material* in forms other than those specified in para. 517, with an activity not exceeding the limit specified in column 4 of Table 3, may be transported in an *excepted package* provided that:

- (a) the *package* retains its *radioactive contents* under routine conditions of transport; and
- (b) the *package* bears the marking “RADIOACTIVE” on an internal surface in such a manner that a warning of the presence of *radioactive material* is visible on opening the *package*.

519. A manufactured article in which the sole *radioactive material* is *unirradiated natural uranium*, *unirradiated depleted uranium* or *unirradiated natural thorium* may be transported as an *excepted package* provided that the

SECTION V

outer surface of the uranium or thorium is enclosed in an inactive sheath made of metal or some other substantial material.

Additional requirements and controls for transport of empty packagings

520. An empty *packaging* which had previously contained *radioactive material* may be transported as an *excepted package* provided that:

- (a) It is in a well maintained condition and securely closed;
- (b) The outer surface of any uranium or thorium in its structure is covered with an inactive sheath made of metal or some other substantial material;
- (c) The level of internal *non-fixed contamination* does not exceed one hundred times the levels specified in para. 508; and
- (d) Any labels which may have been displayed on it in conformity with para. 542 are no longer visible.

REQUIREMENTS AND CONTROLS FOR TRANSPORT OF LSA MATERIAL AND SCO IN INDUSTRIAL PACKAGES OR UNPACKAGED

521. The quantity of *LSA material* or *SCO* in a single *Type IP-1*, *Type IP-2*, *Type IP-3*, or object or collection of objects, whichever is appropriate, shall be so restricted that the external *radiation level* at 3 m from the unshielded material or object or collection of objects does not exceed 10 mSv/h.

522. For *LSA material* and *SCO* which is or contains *fissile material* the applicable requirements of paras 569, 570 and 671 shall be met.

523. *LSA material* and *SCO* in groups *LSA-I* and *SCO-I* may be transported unpackaged under the following conditions:

- (a) All unpackaged material other than ores containing only naturally occurring radionuclides shall be transported in such a manner that under routine conditions of transport there will be no escape of the *radioactive contents* from the *conveyance* nor will there be any loss of shielding;
- (b) Each *conveyance* shall be under *exclusive use*, except when only transporting *SCO-I* on which the *contamination* on the accessible and the inaccessible surfaces is not greater than ten times the applicable level specified in para. 214; and

REQUIREMENTS AND CONTROLS FOR TRANSPORT

TABLE 4. INDUSTRIAL PACKAGE REQUIREMENTS FOR LSA MATERIAL AND SCO

<i>Radioactive contents</i>	<i>Industrial package type</i>	
	<i>Exclusive use</i>	<i>Not under exclusive use</i>
<i>LSA-I</i>		
Solid ^a	<i>Type IP-1</i>	<i>Type IP-1</i>
Liquid	<i>Type IP-1</i>	<i>Type IP-2</i>
<i>LSA-II</i>		
Solid	<i>Type IP-2</i>	<i>Type IP-2</i>
Liquid and gas	<i>Type IP-2</i>	<i>Type IP-3</i>
<i>LSA-III</i>	<i>Type IP-2</i>	<i>Type IP-3</i>
<i>SCO-I^a</i>	<i>Type IP-1</i>	<i>Type IP-1</i>
<i>SCO-II</i>	<i>Type IP-2</i>	<i>Type IP-2</i>

^a Under the conditions specified in para. 523, *LSA-I material* and *SCO-I* may be transported unpackaged.

- (c) For *SCO-I* where it is suspected that *non-fixed contamination* exists on inaccessible surfaces in excess of the values specified in para. 241(a)(i), measures shall be taken to ensure that the *radioactive material* is not released into the *conveyance*.

524. *LSA material* and *SCO*, except as otherwise specified in para. 523, shall be packaged in accordance with Table 4.

525. The total activity in a single hold or compartment of an inland watercraft, or in another *conveyance*, for carriage of *LSA material* or *SCO* in *Type IP-1*, *Type IP-2*, *Type IP-3* or unpackaged, shall not exceed the limits shown in Table 5.

DETERMINATION OF TRANSPORT INDEX

526. The *transport index (TI)* for a *package*, *overpack* or *freight container*, or for unpackaged *LSA-I* or *SCO-I*, shall be the number derived in accordance with the following procedure:

SECTION V

TABLE 5. CONVEYANCE ACTIVITY LIMITS FOR LSA MATERIAL AND SCO IN INDUSTRIAL PACKAGES OR UNPACKAGED

Nature of material	Activity limit for conveyances other than by inland waterway	Activity limit for a hold or compartment of an inland watercraft
<i>LSA-I</i>	No limit	No limit
<i>LSA-II</i> and <i>LSA-III</i> non-combustible solids	No limit	$100A_2$
<i>LSA-II</i> and <i>LSA-III</i> combustible solids, and all liquids and gases	$100A_2$	$10A_2$
<i>SCO</i>	$100A_2$	$10A_2$

- (a) Determine the maximum *radiation level* in units of millisieverts per hour (mSv/h) at a distance of 1 m from the external surfaces of the *package*, *overpack*, *freight container* or unpackaged *LSA-I* and *SCO-I*. The value determined shall be multiplied by 100 and the resulting number is the *transport index*. For uranium and thorium ores and their concentrates, the maximum *radiation level* at any point 1 m from the external surface of the load may be taken as:
- (i) 0.4 mSv/h for ores and physical concentrates of uranium and thorium;
 - (ii) 0.3 mSv/h for chemical concentrates of thorium;
 - (iii) 0.02 mSv/h for chemical concentrates of uranium, other than uranium hexafluoride.
- (b) For *tanks*, *freight containers* and unpackaged *LSA-I* and *SCO-I*, the value determined in step (a) above shall be multiplied by the appropriate factor from Table 6.
- (c) The value obtained in steps (a) and (b) above shall be rounded up to the first decimal place (e.g. 1.13 becomes 1.2), except that a value of 0.05 or less may be considered as zero.

527. The *transport index* for each *overpack*, *freight container* or *conveyance* shall be determined as either the sum of the *TIs* of all the *packages* contained, or by direct measurement of *radiation level*, except in the case of non-rigid *overpacks*, for which the *transport index* shall be determined only as the sum of the *TIs* of all the *packages*.

REQUIREMENTS AND CONTROLS FOR TRANSPORT

TABLE 6. MULTIPLICATION FACTORS FOR TANKS, FREIGHT CONTAINERS, AND UNPACKAGED LSA-I AND SCO-I

Size of load ^a	Multiplication factor
size of load $\leq 1 \text{ m}^2$	1
$1 \text{ m}^2 < \text{size of load} \leq 5 \text{ m}^2$	2
$5 \text{ m}^2 < \text{size of load} \leq 20 \text{ m}^2$	3
$20 \text{ m}^2 < \text{size of load}$	10

^a Largest cross-sectional area of the load being measured.

DETERMINATION OF CRITICALITY SAFETY INDEX

528. The *criticality safety index (CSI)* for *packages* containing *fissile material* shall be obtained by dividing the number 50 by the smaller of the two values of *N* derived in paras 681 and 682 (i.e. $CSI = 50/N$). The value of the *criticality safety index* may be zero, provided that an unlimited number of *packages* is subcritical (i.e. *N* is effectively equal to infinity in both cases).

529. The *criticality safety index* for each *overpack* or *freight container* shall be determined as the sum of the *CSIs* of all the *packages* contained. The same procedure shall be followed for determining the total sum of the *CSIs* in a *consignment* or aboard a *conveyance*.

LIMITS ON TRANSPORT INDEX, CRITICALITY SAFETY INDEX AND RADIATION LEVELS FOR PACKAGES AND OVERPACKS

530. Except for *consignments* under *exclusive use*, the *transport index* of any *package* or *overpack* shall not exceed 10, nor shall the *criticality safety index* of any *package* or *overpack* exceed 50.

531. Except for *packages* or *overpacks* transported under *exclusive use* by rail or by road under the conditions specified in para. 573(a), or under *exclusive use* and *special arrangement* by *vessel* or by air under the conditions specified in paras 575 or 579 respectively, the maximum *radiation level* at any point on the external surface of a *package* or *overpack* shall not exceed 2 mSv/h.

SECTION V

532. The maximum *radiation level* at any point on the external surface of a *package* or *overpack* under *exclusive use* shall not exceed 10 mSv/h.

CATEGORIES

533. *Packages* and *overpacks* shall be assigned to either category I-WHITE, II-YELLOW or III-YELLOW in accordance with the conditions specified in Table 7 and with the following requirements:

- (a) For a *package* or *overpack*, both the *transport index* and the surface *radiation level* conditions shall be taken into account in determining which is the appropriate category. Where the *transport index* satisfies the condition for one category but the surface *radiation level* satisfies the condition for a different category, the *package* or *overpack* shall be assigned to the higher category. For this purpose, category I-WHITE shall be regarded as the lowest category.
- (b) The *transport index* shall be determined following the procedures specified in paras 526 and 527.
- (c) If the surface *radiation level* is greater than 2 mSv/h, the *package* or *overpack* shall be transported under *exclusive use* and under the provisions of paras 573(a), 575 or 579, as appropriate.

TABLE 7. CATEGORIES OF PACKAGES AND OVERPACKS

Conditions		Category
<i>Transport index</i>	Maximum <i>radiation level</i> at any point on external surface	
0 ^a	Not more than 0.005 mSv/h	I-WHITE
More than 0 but not more than 1 ^a	More than 0.005 mSv/h but not more than 0.5 mSv/h	II-YELLOW
More than 1 but not more than 10	More than 0.5 mSv/h but not more than 2 mSv/h	III-YELLOW
More than 10	More than 2 mSv/h but not more than 10 mSv/h	III-YELLOW ^b

^a If the measured *TI* is not greater than 0.05, the value quoted may be zero in accordance with para. 526(c).

^b Shall also be transported under *exclusive use*.

REQUIREMENTS AND CONTROLS FOR TRANSPORT

- (d) A *package* transported under a *special arrangement* shall be assigned to category III-YELLOW except under the provisions of para. 534.
- (e) An *overpack* which contains *packages* transported under *special arrangement* shall be assigned to category III-YELLOW except under the provisions of para. 534.

MARKING, LABELLING AND PLACARDING

534. For each *package* or *overpack* the UN number and proper shipping name shall be determined (see Table 8). In all cases of international transport of *packages* requiring *competent authority design* or shipment approval, for which different approval types apply in the different countries concerned by the shipment, the UN number, proper shipping name, categorization, labelling and marking shall be in accordance with the certificate of the country of origin of *design*.

Marking

535. Each *package* shall be legibly and durably marked on the outside of the *packaging* with an identification of either the *consignor* or *consignee*, or both.

536. For each *package*, other than *excepted packages*, the United Nations number (see Table 8), preceded by the letters “UN”, and the proper shipping name (see Table 8) shall be legibly and durably marked on the outside of the *packaging*. In the case of *excepted packages*, other than those accepted for international movement by post, only the United Nations number, preceded by the letters “UN”, shall be required. For *packages* accepted for international movement by post the requirement of para. 581 shall apply.

SECTION V

TABLE 8. EXCERPTS FROM LIST OF UNITED NATIONS NUMBERS, PROPER SHIPPING NAMES AND DESCRIPTIONS AND SUBSIDIARY RISKS

UN No.	PROPER SHIPPING NAME ^a and description	Subsidiary risks
2910	RADIOACTIVE MATERIAL, EXCEPTED PACKAGE – LIMITED QUANTITY OF MATERIAL	
2911	RADIOACTIVE MATERIAL, EXCEPTED PACKAGE – INSTRUMENTS or ARTICLES	
2909	RADIOACTIVE MATERIAL, EXCEPTED PACKAGE – ARTICLES MANUFACTURED FROM NATURAL URANIUM or DEPLETED URANIUM or NATURAL THORIUM	
2908	RADIOACTIVE MATERIAL, EXCEPTED PACKAGE – EMPTY PACKAGING	
2912	RADIOACTIVE MATERIAL, LOW SPECIFIC ACTIVITY (LSA-I) non-fissile or fissile-excepted ^b	
3321	RADIOACTIVE MATERIAL, LOW SPECIFIC ACTIVITY (LSA-II) non-fissile or fissile-excepted ^b	
3322	RADIOACTIVE MATERIAL, LOW SPECIFIC ACTIVITY (LSA-III) non-fissile or fissile-excepted ^b	
2913	RADIOACTIVE MATERIAL, SURFACE CONTAMINATED OBJECTS (SCO-I or SCO-II) non-fissile or fissile-excepted ^b	
2915	RADIOACTIVE MATERIAL, TYPE A PACKAGE, non-special form, non-fissile or fissile-excepted ^b	
3332	RADIOACTIVE MATERIAL, TYPE A PACKAGE, SPECIAL FORM non-fissile or fissile-excepted ^b	
2916	RADIOACTIVE MATERIAL, TYPE B(U) PACKAGE, non-fissile or fissile-excepted ^b	
2917	RADIOACTIVE MATERIAL, TYPE B(M) PACKAGE, non-fissile or fissile-excepted ^b	
3323	RADIOACTIVE MATERIAL, TYPE C PACKAGE, non-fissile or fissile-excepted ^b	
2919	RADIOACTIVE MATERIAL, TRANSPORTED UNDER SPECIAL ARRANGEMENT, non-fissile or fissile-excepted ^b	
2978	RADIOACTIVE MATERIAL, URANIUM HEXA-FLUORIDE non-fissile or fissile-excepted ^{b,c}	Corrosive (UN Class 8)

REQUIREMENTS AND CONTROLS FOR TRANSPORT

TABLE 8. EXCERPTS FROM LIST OF UNITED NATIONS NUMBERS, PROPER SHIPPING NAMES AND DESCRIPTIONS AND SUBSIDIARY RISKS (cont.)

UN No.	PROPER SHIPPING NAME ^a and description	Subsidiary risks
3324	RADIOACTIVE MATERIAL, LOW SPECIFIC ACTIVITY (LSA-II), FISSILE	
3325	RADIOACTIVE MATERIAL, LOW SPECIFIC ACTIVITY (LSA-III), FISSILE	
3326	RADIOACTIVE MATERIAL, SURFACE CONTAMINATED OBJECTS (SCO-I or SCO-II), FISSILE	
3327	RADIOACTIVE MATERIAL, TYPE A PACKAGE, FISSILE non-special form	
3333	RADIOACTIVE MATERIAL, TYPE A PACKAGE, SPECIAL FORM, FISSILE	
3328	RADIOACTIVE MATERIAL, TYPE B(U) PACKAGE, FISSILE	
3329	RADIOACTIVE MATERIAL, TYPE B(M) PACKAGE, FISSILE	
3330	RADIOACTIVE MATERIAL, TYPE C PACKAGE, FISSILE	
3331	RADIOACTIVE MATERIAL, TRANSPORTED UNDER SPECIAL ARRANGEMENT, FISSILE	
2977	RADIOACTIVE MATERIAL, URANIUM HEXAFLUORIDE, FISSILE ^c	Corrosive (UN Class 8)

^a The “PROPER SHIPPING NAME” is found in the column “PROPER SHIPPING NAME and description” and is restricted to that part shown in CAPITAL LETTERS. In the case of UN 2909, UN 2911, UN 2913 and UN 3326 where alternative proper shipping names are separated by the word “or”, only the relevant proper shipping name shall be used.

^b “Fissile-excepted” applies only to those packages complying with para. 672.

^c In the case of non-fissile or fissile-excepted uranium hexafluoride, UN 2978 and the proper shipping name and description, “RADIOACTIVE MATERIAL, URANIUM HEXAFLUORIDE, non-fissile or fissile-excepted”, takes precedence over other UN numbers applicable to non-fissile and fissile-excepted. In the case of uranium hexafluoride that is fissile material, UN 2977 and the proper shipping name, “RADIOACTIVE MATERIAL, URANIUM HEXAFLUORIDE, FISSILE”, takes precedence over other UN numbers applicable to fissile material.

SECTION V

537. Each *package* of gross mass exceeding 50 kg shall have its permissible gross mass legibly and durably marked on the outside of the *packaging*.

538. Each *package* which conforms to:

- (a) An *IP-1*, an *IP-2* or an *IP-3 design* shall be legibly and durably marked on the outside of the *packaging* with “TYPE IP-1”, “TYPE IP-2” or “TYPE IP-3” as appropriate;
- (b) A *Type A package design* shall be legibly and durably marked on the outside of the *packaging* with “TYPE A”;
- (c) An *IP-2*, an *IP-3* or a *Type A package design* shall be legibly and durably marked on the outside of the *packaging* with the international *vehicle* registration code (VRI Code) of the country of origin of *design* and either the name of the manufacturer or other identification of the *packaging* specified by the *competent authority* of the country of origin of *design*.

539. Each *package* which conforms to a *design* approved under paras 805–814 or 816–817 shall be legibly and durably marked on the outside of the *packaging* with:

- (a) The identification mark allocated to that *design* by the *competent authority*;
- (b) A serial number to uniquely identify each *packaging* which conforms to that *design*;
- (c) In the case of a *Type B(U)* or *Type B(M) package design*, with “TYPE B(U)” or “TYPE B(M)”;
- (d) In the case of a *Type C package design*, with “TYPE C”.

540. Each *package* which conforms to a *Type B(U)*, *Type B(M)* or *Type C package design* shall have the outside of the outermost receptacle which is resistant to the effects of fire and water plainly marked by embossing, stamping or other means resistant to the effects of fire and water with the trefoil symbol shown in Fig. 1.

541. Where *LSA-I* or *SCO-I material* is contained in receptacles or wrapping materials and is transported under *exclusive use* as permitted by para. 523, the outer surface of these receptacles or wrapping materials may bear the marking ‘RADIOACTIVE LSA-I’ or ‘RADIOACTIVE SCO-I’ as appropriate.

REQUIREMENTS AND CONTROLS FOR TRANSPORT

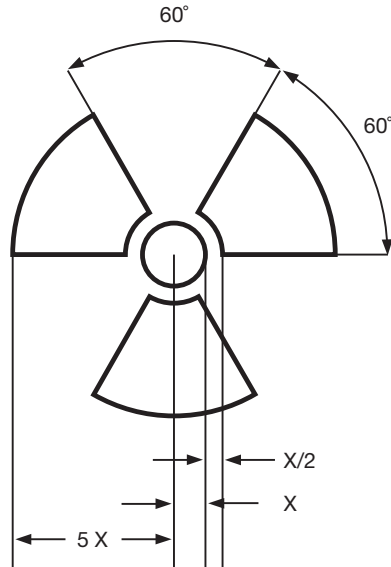

FIG. 1. Basic trefoil symbol with proportions based on a central circle of radius X . The minimum allowable size of X shall be 4 mm.

Labelling

542. Each *package*, *overpack* and *freight container* shall bear the labels which conform to the models in Fig. 2, Fig. 3 or Fig. 4, except as allowed under the alternative provisions of para. 547 for large *freight containers* and *tanks*, according to the appropriate category. In addition, each *package*, *overpack* and *freight container* containing *fissile material*, other than *fissile material* excepted under the provisions of para. 672, shall bear labels which conform to the model in Fig. 5. Any labels which do not relate to the contents shall be removed or covered. For *radioactive material* having other dangerous properties see para. 507.

543. The labels conforming to the models in Fig. 2, Fig. 3 and Fig. 4 shall be affixed to two opposite sides of the outside of a *package* or *overpack* or on the outside of all four sides of a *freight container* or *tank*. The labels conforming to the model in Fig. 5, where applicable, shall be affixed adjacent to the labels conforming to the models in Fig. 2, Fig. 3 and Fig. 4. The labels shall not cover the markings specified in paras 535–540.

SECTION V

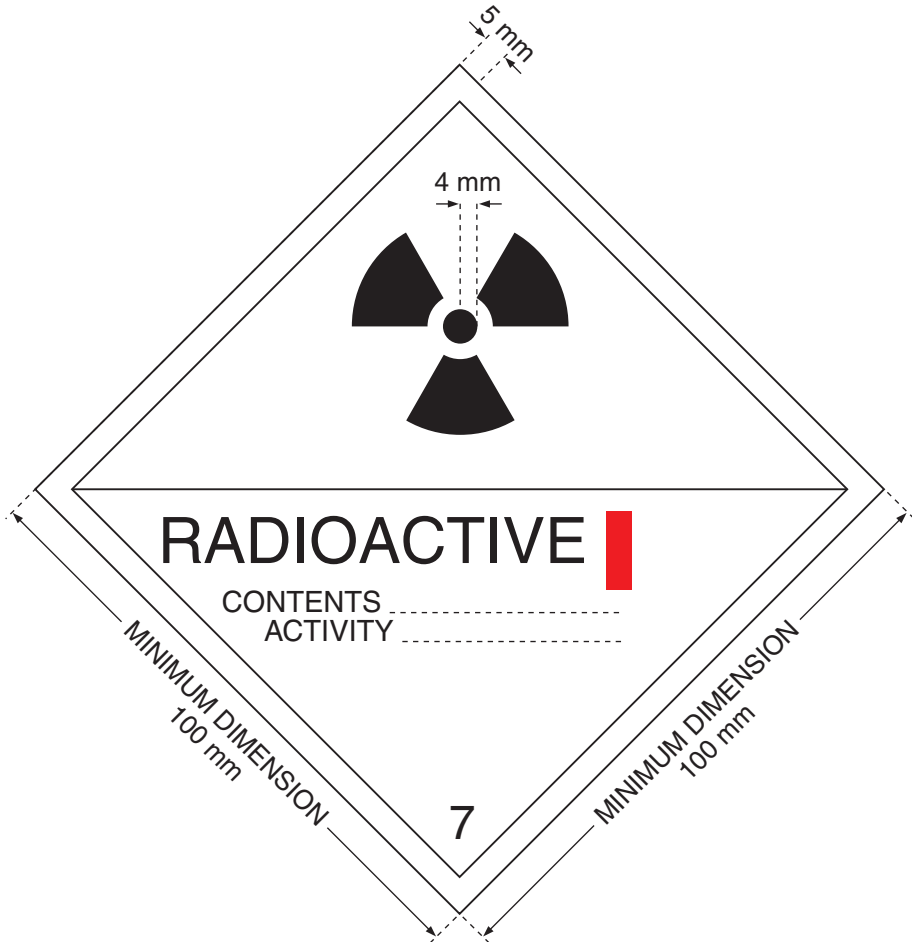

FIG. 2. Category I-WHITE label. The background colour of the label shall be white, the colour of the trefoil and the printing shall be black, and the colour of the category bar shall be red.

Labelling for radioactive contents

544. Each label conforming to the models in Fig. 2, Fig. 3 and Fig. 4 shall be completed with the following information:

- (a) Contents:
 - (i) Except for *LSA-I material*, the name(s) of the radionuclide(s) as taken from Table 1, using the symbols prescribed therein. For

REQUIREMENTS AND CONTROLS FOR TRANSPORT

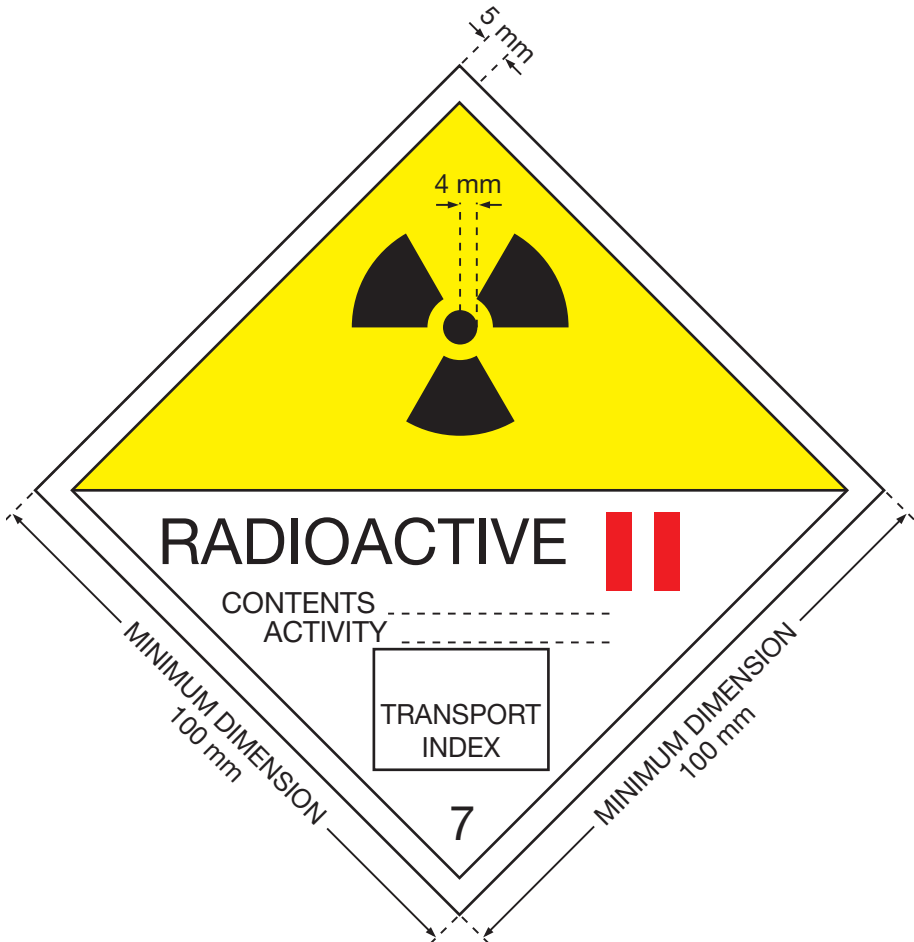

FIG. 3. Category II-YELLOW label. The background colour of the upper half of the label shall be yellow and the lower half white, the colour of the trefoil and the printing shall be black, and the colour of the category bars shall be red.

mixtures of radionuclides, the most restrictive nuclides must be listed to the extent the space on the line permits. The group of *LSA* or *SCO* shall be shown following the name(s) of the radionuclide(s). The terms “LSA-II”, “LSA-III”, “SCO-I” and “SCO-II” shall be used for this purpose.

- (ii) For *LSA-I* material, the term “LSA-I” is all that is necessary; the name of the radionuclide is not necessary.
- (b) Activity: The maximum activity of the *radioactive contents* during transport expressed in units of becquerels (Bq) with the appropriate SI

SECTION V

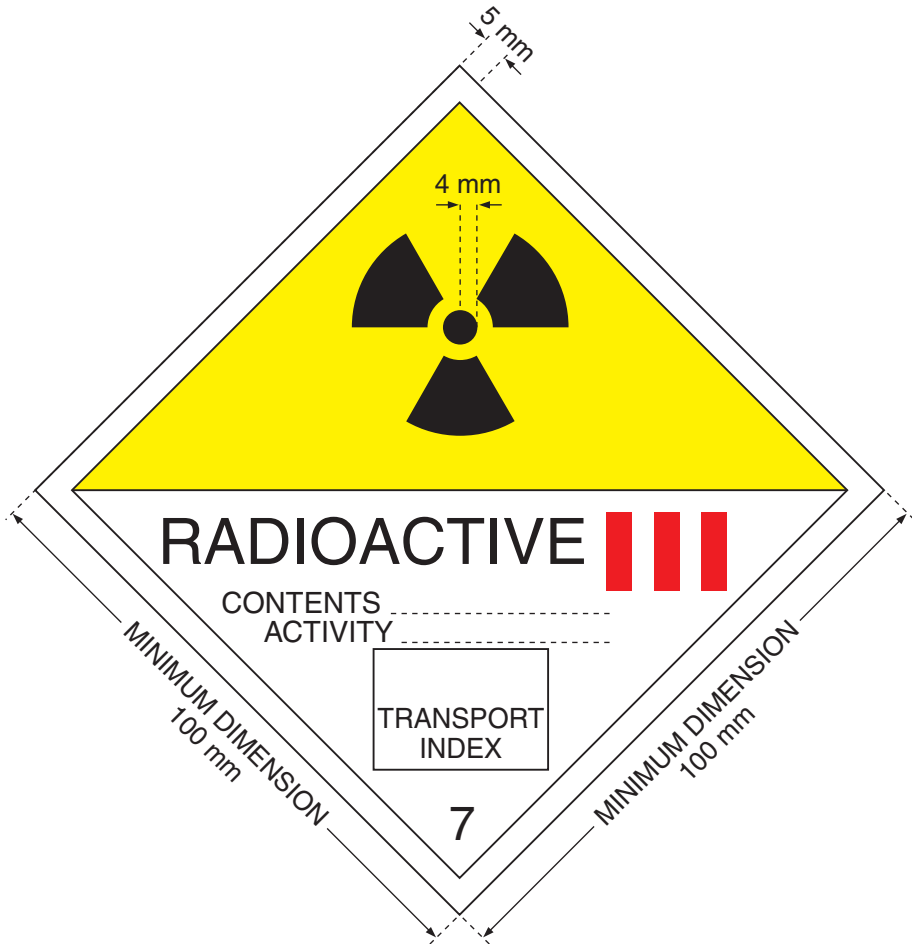

FIG. 4. Category III-YELLOW label. The background colour of the upper half of the label shall be yellow and the lower half white, the colour of the trefoil and the printing shall be black, and the colour of the category bars shall be red.

prefix symbol (see Annex II). For *fissile material*, the mass of *fissile material* in units of grams (g), or multiples thereof, may be used in place of activity.

- (c) For *overpacks* and *freight containers* the “contents” and “activity” entries on the label shall bear the information required in paras 544(a) and 544(b), respectively, totalled together for the entire contents of the *overpack* or *freight container* except that on labels for *overpacks* or *freight containers* containing mixed loads of *packages* containing different radionuclides, such entries may read “See Transport Documents”.

REQUIREMENTS AND CONTROLS FOR TRANSPORT

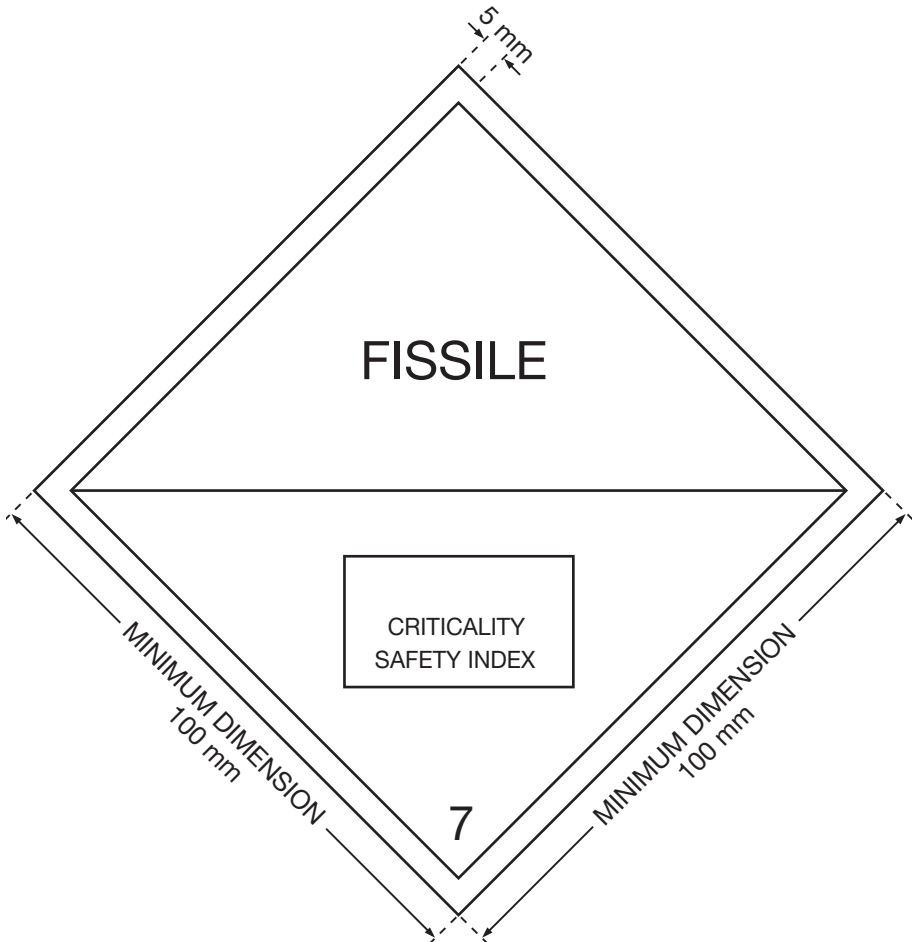

FIG. 5. Criticality safety index label. The background colour of the label shall be white, the colour of the printing shall be black.

- (d) *Transport index*: See paras 526 and 527. (No *transport index* entry is required for category I-WHITE.)

Labelling for criticality safety

545. Each label conforming to the model in Fig. 5 shall be completed with the *criticality safety index (CSI)* as stated in the certificate of approval for *special arrangement* or the certificate of approval for the *package design* issued by the *competent authority*.

SECTION V

546. For *overpacks* and *freight containers*, the *criticality safety index (CSI)* on the label shall bear the information required in para. 545 totalled together for the fissile contents of the *overpack* or *freight container*.

Placarding

547. Large *freight containers* carrying *packages* other than *excepted packages*, and *tanks*, shall bear four placards which conform to the model given in Fig. 6. The placards shall be affixed in a vertical orientation to each side wall and each end wall of the large *freight container* or *tank*. Any placards which do not relate to the contents shall be removed. Instead of using both labels and placards, it is permitted as an alternative to use enlarged labels only, where appropriate, as shown in Fig. 2, Fig. 3, Fig. 4 and Fig. 5, with dimensions of the minimum size shown in Fig. 6.

548. Where the *consignment* in the *freight container* or *tank* is unpackaged *LSA-I* or *SCO-I* or where an *exclusive use consignment* in a *freight container* is packaged *radioactive material* with a single United Nations number, the appropriate United Nations number for the *consignment* (see Table 8) shall also be displayed, in black digits not less than 65 mm high, either:

- (a) in the lower half of the placard shown in Fig. 6 and against the white background, or
- (b) on the placard shown in Fig. 7.

When the alternative given in (b) above is used, the subsidiary placard shall be affixed immediately adjacent to the main placard, on all four sides of the *freight container* or *tank*.

CONSIGNOR'S RESPONSIBILITIES

549. Compliance with the requirements of paras 520(d) and 534–548 for marking, labelling and placarding shall be the responsibility of the *consignor*.

Particulars of consignment

550. The *consignor* shall include in the transport documents with each *consignment* the identification of the consignor and consignee, including their names and addresses and the following information, as applicable, in the order given:

REQUIREMENTS AND CONTROLS FOR TRANSPORT

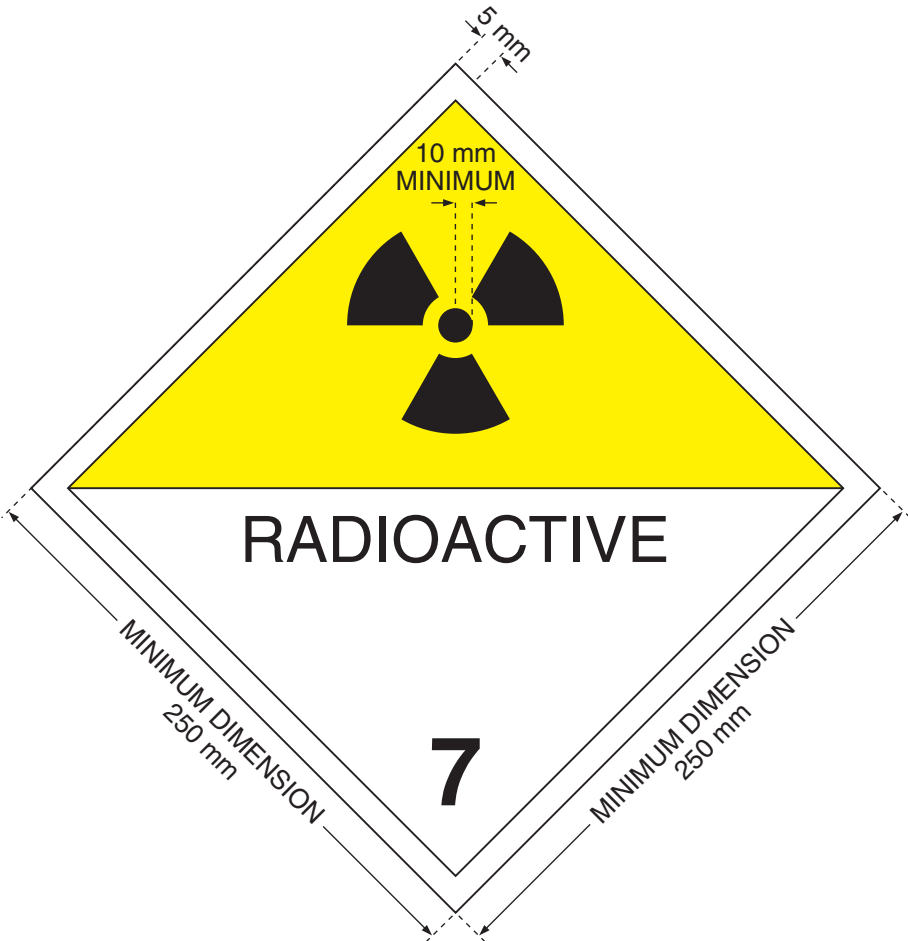

FIG. 6. Placard. Except as permitted by para. 571 minimum dimensions shall be as shown; when different dimensions are used the relative proportions must be maintained. The number '7' shall not be less than 25 mm high. The background colour of the upper half of the placard shall be yellow and of the lower half white, the colour of the trefoil and the printing shall be black. The use of the word "RADIOACTIVE" in the bottom half is optional to allow the alternative use of this placard to display the appropriate United Nations number for the consignment.

- (a) The proper shipping name, as specified in accordance with the provisions of para. 534;
- (b) The United Nations Class number "7";
- (c) The United Nations number assigned to the material as specified in accordance with the provisions of para. 534, preceded by the letters "UN";

SECTION V

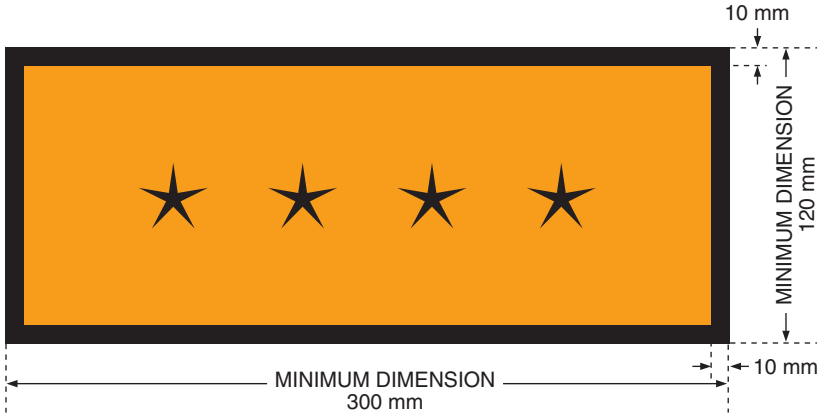

FIG. 7. Placard for separate display of United Nations number. The background colour of the placard shall be orange and the border and United Nations number shall be black. The symbol “****” denotes the space in which the appropriate United Nations number for radioactive material, as specified in Table 8, shall be displayed.

- (d) The name or symbol of each radionuclide or, for mixtures of radionuclides, an appropriate general description or a list of the most restrictive nuclides;
- (e) A description of the physical and chemical form of the material, or a notation that the material is *special form radioactive material* or *low dispersible radioactive material*. A generic chemical description is acceptable for chemical form;
- (f) The maximum activity of the *radioactive contents* during transport expressed in units of becquerels (Bq) with the appropriate SI prefix symbol (see Annex II). For *fissile material*, the mass of *fissile material* in units of grams (g), or appropriate multiples thereof, may be used in place of activity;
- (g) The category of the *package*, i.e. I-WHITE, II-YELLOW, III-YELLOW;
- (h) The *transport index* (categories II-YELLOW and III-YELLOW only);
- (i) For *consignments* including *fissile material* other than *consignments* excepted under para. 672, the *criticality safety index*;
- (j) The identification mark for each *competent authority* approval certificate (*special form radioactive material*, *low dispersible radioactive material*, *special arrangement*, *package design* or *shipment*) applicable to the *consignment*;
- (k) For *consignments* of more than one *package*, the information contained in paras 550(a)–(j) shall be given for each *package*. For *packages* in an *overpack*, *freight container* or *conveyance*, a detailed statement of the

REQUIREMENTS AND CONTROLS FOR TRANSPORT

contents of each *package* within the *overpack*, *freight container* or *conveyance* and, where appropriate, of each *overpack*, *freight container* or *conveyance* shall be included. If *packages* are to be removed from the *overpack*, *freight container* or *conveyance* at a point of intermediate unloading, appropriate transport documents shall be made available;

- (l) Where a *consignment* is required to be shipped under *exclusive use*, the statement “EXCLUSIVE USE SHIPMENT”; and
- (m) For *LSA-II*, *LSA-III*, *SCO-I* and *SCO-II*, the total activity of the *consignment* as a multiple of A_2 .

Consignor’s declaration

551. The *consignor* shall include in the transport documents a declaration in the following terms or in terms having an equivalent meaning:

“I hereby declare that the contents of this consignment are fully and accurately described above by the proper shipping name and are classified, packed, marked and labelled, and are in all respects in proper condition for transport by (insert mode(s) of transport involved) according to the applicable international and national governmental regulations.”

552. If the intent of the declaration is already a condition of transport within a particular international convention, the *consignor* need not provide such a declaration for that part of the transport covered by the convention.

553. The declaration shall be signed and dated by the *consignor*. Facsimile signatures are acceptable where applicable laws and regulations recognize the legal validity of facsimile signatures.

554. The declaration shall be made on the same transport document which contains the particulars of *consignment* listed in para. 550.

Removal or covering of labels

555. When an empty *packaging* is transported as an *excepted package* under the provisions of para. 520, the previously displayed labels shall not be visible.

SECTION V

Information for carriers

556. The *consignor* shall provide in the transport documents a statement regarding actions, if any, that are required to be taken by the *carrier*. The statement shall be in the languages deemed necessary by the *carrier* or the authorities concerned, and shall include at least the following points:

- (a) Supplementary requirements for loading, stowage, carriage, handling and unloading of the *package*, *overpack* or *freight container* including any special stowage provisions for the safe dissipation of heat (see para. 566), or a statement that no such requirements are necessary;
- (b) Restrictions on the mode of transport or *conveyance* and any necessary routing instructions;
- (c) Emergency arrangements appropriate to the *consignment*.

557. The applicable *competent authority* certificates need not necessarily accompany the *consignment*. The *consignor* shall make them available to the *carrier(s)* before loading and unloading.

Notification of competent authorities

558. Before the first *shipment* of any *package* requiring *competent authority* approval, the *consignor* shall ensure that copies of each applicable *competent authority* certificate applying to that *package design* have been submitted to the *competent authority* of each country through or into which the *consignment* is to be transported. The *consignor* is not required to await an acknowledgement from the *competent authority*, nor is the *competent authority* required to make such acknowledgement of receipt of the certificate.

559. For each *shipment* listed in (a), (b), (c) or (d) below, the *consignor* shall notify the *competent authority* of each country through or into which the *consignment* is to be transported. This notification shall be in the hands of each *competent authority* prior to the commencement of the *shipment*, and preferably at least 7 days in advance.

- (a) *Type C packages* containing *radioactive material* with an activity greater than $3000A_1$ or $3000A_2$, as appropriate, or 1000 TBq, whichever is the lower;
- (b) *Type B(U) packages* containing *radioactive material* with an activity greater than $3000A_1$ or $3000A_2$, as appropriate, or 1000 TBq, whichever is the lower;

REQUIREMENTS AND CONTROLS FOR TRANSPORT

- (c) *Type B(M) packages*;
- (d) *Shipments under special arrangement*.

560. The *consignment* notification shall include:

- (a) Sufficient information to enable the identification of the *package* or *packages* including all applicable certificate numbers and identification marks;
- (b) Information on the date of *shipment*, the expected date of arrival and proposed routing;
- (c) The names of the *radioactive materials* or nuclides;
- (d) Descriptions of the physical and chemical forms of the *radioactive material*, or whether it is *special form radioactive material* or *low dispersible radioactive material*; and
- (e) The maximum activity of the *radioactive contents* during transport expressed in units of becquerels (Bq) with the appropriate SI prefix symbol (see Annex II). For *fissile material*, the mass of *fissile material* in units of grams (g), or multiples thereof, may be used in place of activity.

561. The *consignor* is not required to send a separate notification if the required information has been included in the application for *shipment* approval; see para. 822.

Possession of certificates and instructions

562. The *consignor* shall have in his or her possession a copy of each certificate required under Section VIII of these Regulations and a copy of the instructions with regard to the proper closing of the *package* and other preparations for *shipment* before making any *shipment* under the terms of the certificates.

TRANSPORT AND STORAGE IN TRANSIT

Segregation during transport and storage in transit

563. *Packages, overpacks and freight containers* containing *radioactive material* and unpackaged *radioactive material* shall be segregated during transport and during storage in transit:

SECTION V

- (a) from workers in regularly occupied working areas by distances calculated using a dose criterion of 5 mSv in a year and conservative model parameters;
- (b) from members of the critical group of the public, in areas where the public has regular access, by distances calculated using a dose criterion of 1 mSv in a year and conservative model parameters;
- (c) from undeveloped photographic film by distances calculated using a radiation exposure criterion for undeveloped photographic film due to the transport of *radioactive material* of 0.1 mSv per *consignment* of such film; and
- (d) from other dangerous goods in accordance with para. 506.

564. Category II-YELLOW or III-YELLOW *packages* or *overpacks* shall not be carried in compartments occupied by passengers, except those exclusively reserved for couriers specially authorized to accompany such *packages* or *overpacks*.

Stowage during transport and storage in transit

565. *Consignments* shall be securely stowed.

566. Provided that its average surface heat flux does not exceed 15 W/m² and that the immediately surrounding cargo is not in sacks or bags, a *package* or *overpack* may be carried or stored among packaged general cargo without any special stowage provisions except as may be specifically required by the *competent authority* in an applicable approval certificate.

567. Loading of *freight containers* and accumulation of *packages*, *overpacks* and *freight containers* shall be controlled as follows:

- (a) Except under the condition of *exclusive use*, and for consignments of *LSA-I* material, the total number of *packages*, *overpacks* and *freight containers* aboard a single *conveyance* shall be so limited that the total sum of the *transport indexes* aboard the *conveyance* does not exceed the values shown in Table 9.
- (b) The *radiation level* under routine conditions of transport shall not exceed 2 mSv/h at any point on, and 0.1 mSv/h at 2 m from, the external surface of the *conveyance*, except for *consignments* transported under *exclusive use* by road or rail, for which the radiation limits around the *vehicle* are set forth in paras 573(b) and (c).

REQUIREMENTS AND CONTROLS FOR TRANSPORT

TABLE 9. TI LIMITS FOR FREIGHT CONTAINERS AND CONVEYANCES NOT UNDER EXCLUSIVE USE

Type of <i>freight container</i> or <i>conveyance</i>	Limit on total sum of <i>transport indexes</i> in a <i>freight container</i> or aboard a <i>conveyance</i>
<i>Freight container</i> — Small	50
<i>Freight container</i> — Large	50
<i>Vehicle</i>	50
<i>Aircraft</i>	
<i>Passenger</i>	50
<i>Cargo</i>	200
Inland waterway <i>vessel</i>	50
Seagoing <i>vessel</i> ^a	
(1) Hold, compartment or <i>defined deck area</i> :	
<i>Packages, overpacks, small freight containers</i>	50
<i>Large freight containers</i>	200
(2) Total <i>vessel</i> :	
<i>Packages, overpacks, small freight containers</i>	200
<i>Large freight containers</i>	No limit

^a *Packages* or *overpacks* carried in or on a *vehicle* which are in accordance with the provisions of para. 573 may be transported by *vessels* provided that they are not removed from the *vehicle* at any time while on board the *vessel*.

(c) The total sum of the *criticality safety indexes* in a *freight container* and aboard a *conveyance* shall not exceed the values shown in Table 10.

568. Any *package* or *overpack* having a *transport index* greater than 10, or any *consignment* having a *criticality safety index* greater than 50, shall be transported only under *exclusive use*.

Segregation of packages containing fissile material during transport and storage in transit

569. Any group of *packages, overpacks* and *freight containers* containing *fissile material* stored in transit in any one storage area shall be so limited that the total sum of the *criticality safety indexes* in the group does not exceed 50. Each group shall be stored so as to maintain a spacing of at least 6 m from other such groups.

SECTION V

TABLE 10. CSI LIMITS FOR FREIGHT CONTAINERS AND CONVEYANCES CONTAINING FISSILE MATERIAL

Type of <i>freight container</i> or <i>conveyance</i>	Limit on total sum of <i>criticality safety indexes</i> in a <i>freight container</i> or aboard a <i>conveyance</i>	
	Not under <i>exclusive use</i>	Under <i>exclusive use</i>
<i>Freight container</i> — Small	50	n.a.
<i>Freight container</i> — Large	50	100
<i>Vehicle</i>	50	100
<i>Aircraft</i>		
<i>Passenger</i>	50	n.a.
<i>Cargo</i>	50	100
Inland waterway vessel	50	100
Seagoing vessel ^a		
(1) Hold, compartment or <i>defined deck area</i> :		
<i>Packages, overpacks, small freight containers</i>	50	100
<i>Large freight containers</i>	50	100
(2) Total vessel:		
<i>Packages, overpacks, small freight containers</i>	200 ^b	200 ^c
<i>Large freight containers</i>	No limit ^b	No limit ^c

^a *Packages* or *overpacks* carried in or on a *vehicle* which are in accordance with the provisions of para. 573 may be transported by *vessels* provided that they are not removed from the *vehicle* at any time while on board the *vessel*. In that case the entries under the heading 'under *exclusive use*' apply.

^b The *consignment* shall be so handled and stowed that the total sum of *CSIs* in any group does not exceed 50, and that each group is handled and stowed so that the groups are separated from each other by at least 6 m.

^c The *consignment* shall be so handled and stowed that the total sum of *CSIs* in any group does not exceed 100, and that each group is handled and stowed so that the groups are separated from each other by at least 6 m. The intervening space between groups may be occupied by other cargo in accordance with para. 505.

570. Where the total sum of the *criticality safety indexes* on board a *conveyance* or in a *freight container* exceeds 50, as permitted in Table 10, storage shall be such as to maintain a spacing of at least 6 m from other groups of *packages, overpacks* or *freight containers* containing *fissile material* or other *conveyances* carrying *radioactive material*.

REQUIREMENTS AND CONTROLS FOR TRANSPORT

Additional requirements relating to transport by rail and by road

571. Rail and road *vehicles* carrying *packages*, *overpacks* or *freight containers* labelled with any of the labels shown in Fig. 2, Fig. 3, Fig. 4 or Fig. 5, or carrying *consignments* under *exclusive use*, shall display the placard shown in Fig. 6 on each of:

- (a) The two external lateral walls in the case of a rail *vehicle*;
- (b) The two external lateral walls and the external rear wall in the case of a road *vehicle*.

In the case of a *vehicle* without sides, the placards may be affixed directly on the cargo carrying unit provided that they are readily visible; in the case of physically large *tanks* or *freight containers*, the placards on the *tanks* or *freight containers* shall suffice. In the case of *vehicles* which have insufficient area to allow the fixing of larger placards, the dimensions of the placard as described in Fig. 6 may be reduced to 100 mm. Any placards which do not relate to the contents shall be removed.

572. Where the *consignment* in or on the *vehicle* is unpackaged *LSA-I material* or *SCO-I* or where an *exclusive use consignment* is packaged *radioactive material* with a single United Nations number, the appropriate United Nations number (see Table 8) shall also be displayed, in black digits not less than 65 mm high, either:

- (a) In the lower half of the placard shown in Fig. 6, against the white background; or
- (b) On the placard shown in Fig. 7.

When the alternative given in (b) above is used, the subsidiary placard shall be affixed immediately adjacent to the main placard, either on the two external lateral walls in the case of a rail *vehicle* or on the two external lateral walls and the external rear wall in the case of a road *vehicle*.

573. For *consignments* under *exclusive use*, the *radiation level* shall not exceed:

- (a) 10 mSv/h at any point on the external surface of any *package* or *overpack*, and may only exceed 2 mSv/h provided that:
 - (i) the *vehicle* is equipped with an enclosure which, during routine conditions of transport, prevents the access of unauthorized persons to the interior of the enclosure; and

SECTION V

- (ii) provisions are made to secure the *package* or *overpack* so that its position within the *vehicle* enclosure remains fixed during routine conditions of transport; and
- (iii) there is no loading or unloading during the *shipment*;
- (b) 2 mSv/h at any point on the outer surfaces of the *vehicle*, including the upper and lower surfaces, or, in the case of an open *vehicle*, at any point on the vertical planes projected from the outer edges of the *vehicle*, on the upper surface of the load, and on the lower external surface of the *vehicle*; and
- (c) 0.1 mSv/h at any point 2 m from the vertical planes represented by the outer lateral surfaces of the *vehicle*, or, if the load is transported in an open *vehicle*, at any point 2 m from the vertical planes projected from the outer edges of the *vehicle*.

574. In the case of road *vehicles*, no persons other than the driver and assistants shall be permitted in *vehicles* carrying *packages*, *overpacks* or *freight containers* bearing category II-YELLOW or III-YELLOW labels.

Additional requirements relating to transport by vessels

575. *Packages* or *overpacks* having a surface *radiation level* greater than 2 mSv/h, unless being carried in or on a *vehicle* under *exclusive use* in accordance with Table 9, footnote (a), shall not be transported by *vessel* except under *special arrangement*.

576. The transport of *consignments* by means of a special use *vessel* which, by virtue of its design, or by reason of its being chartered, is dedicated to the purpose of carrying *radioactive material*, shall be excepted from the requirements specified in para. 567 provided that the following conditions are met:

- (a) A *Radiation Protection Programme* for the *shipment* shall be approved by the *competent authority* of the flag state of the *vessel* and, when requested, by the *competent authority* at each port of call;
- (b) Stowage arrangements shall be predetermined for the whole voyage including any *consignments* to be loaded at ports of call en route; and
- (c) The loading, carriage and unloading of the *consignments* shall be supervised by persons qualified in the transport of *radioactive material*.

REQUIREMENTS AND CONTROLS FOR TRANSPORT

Additional requirements relating to transport by air

577. *Type B(M) packages and consignments under exclusive use shall not be transported on passenger aircraft.*

578. *Vented Type B(M) packages, packages which require external cooling by an ancillary cooling system, packages subject to operational controls during transport and packages containing liquid pyrophoric materials shall not be transported by air.*

579. *Packages or overpacks having a surface radiation level greater than 2 mSv/h shall not be transported by air except by special arrangement.*

Additional requirements relating to transport by post

580. *A consignment that conforms with the requirements of para. 515, and in which the activity of the radioactive contents does not exceed one tenth of the limits prescribed in Table 3, may be accepted for domestic movement by national postal authorities, subject to such additional requirements as those authorities may prescribe.*

581. *A consignment that conforms with the requirements of para. 515, and in which the activity of the radioactive contents does not exceed one tenth of the limits prescribed in Table 3, may be accepted for international movement by post, subject in particular to the following additional requirements as prescribed by the Acts of the Universal Postal Union:*

- (a) *it shall be deposited with the postal service only by consignors authorized by the national authority;*
- (b) *it shall be dispatched by the quickest route, normally by air;*
- (c) *it shall be plainly and durably marked on the outside with the words “RADIOACTIVE MATERIAL – QUANTITIES PERMITTED FOR MOVEMENT BY POST”; these words shall be crossed out if the packaging is returned empty;*
- (d) *it shall carry on the outside the name and address of the consignor with the request that the consignment be returned in the case of non-delivery; and*
- (e) *the name and address of the consignor and the contents of the consignment shall be indicated on the internal packaging.*

SECTION V

CUSTOMS OPERATIONS

582. Customs operations involving the inspection of the *radioactive contents* of a *package* shall be carried out only in a place where adequate means of controlling radiation exposure are provided and in the presence of qualified persons. Any *package* opened on customs instructions shall, before being forwarded to the *consignee*, be restored to its original condition.

UNDELIVERABLE CONSIGNMENTS

583. Where a *consignment* is undeliverable, the *consignment* shall be placed in a safe location and the appropriate *competent authority* shall be informed as soon as possible and a request made for instructions on further action.

Section VI

REQUIREMENTS FOR RADIOACTIVE MATERIALS AND FOR PACKAGINGS AND PACKAGES

REQUIREMENTS FOR RADIOACTIVE MATERIALS

Requirements for LSA-III material

601. *LSA-III material* shall be a solid of such a nature that if the entire contents of a *package* were subjected to the test specified in para. 703 the activity in the water would not exceed $0.1A_2$.

Requirements for special form radioactive material

602. *Special form radioactive material* shall have at least one dimension not less than 5 mm.

603. *Special form radioactive material* shall be of such a nature or shall be so designed that if it is subjected to the tests specified in paras 704–711, it shall meet the following requirements:

- (a) It would not break or shatter under the impact, percussion and bending tests in paras 705, 706, 707 and 709(a) as applicable;
- (b) It would not melt or disperse in the heat test in para. 708 or para. 709(b) as applicable; and
- (c) The activity in the water from the leaching tests specified in paras 710 and 711 would not exceed 2 kBq; or alternatively for sealed sources, the leakage rate for the volumetric leakage assessment test specified in the International Organization for Standardization document ISO 9978: “Radiation Protection — Sealed Radioactive Sources — Leakage Test Methods” [8], would not exceed the applicable acceptance threshold acceptable to the *competent authority*.

604. When a sealed capsule constitutes part of the *special form radioactive material*, the capsule shall be so manufactured that it can be opened only by destroying it.

SECTION VI

Requirements for low dispersible radioactive material

605. *Low dispersible radioactive material* shall be such that the total amount of this *radioactive material* in a *package* shall meet the following requirements:

- (a) The *radiation level* at 3 m from the unshielded *radioactive material* does not exceed 10 mSv/h;
- (b) If subjected to the tests specified in paras 736 and 737, the airborne release in gaseous and particulate forms of up to 100 µm aerodynamic equivalent diameter would not exceed $100A_2$. A separate specimen may be used for each test; and
- (c) If subjected to the test specified in para. 703 the activity in the water would not exceed $100A_2$. In the application of this test, the damaging effects of the tests specified in (b) above shall be taken into account.

GENERAL REQUIREMENTS FOR ALL PACKAGINGS AND PACKAGES

606. The *package* shall be so designed in relation to its mass, volume and shape that it can be easily and safely transported. In addition, the *package* shall be so designed that it can be properly secured in or on the *conveyance* during transport.

607. The *design* shall be such that any lifting attachments on the *package* will not fail when used in the intended manner and that, if failure of the attachments should occur, the ability of the *package* to meet other requirements of these Regulations would not be impaired. The *design* shall take account of appropriate safety factors to cover snatch lifting.

608. Attachments and any other features on the outer surface of the *package* which could be used to lift it shall be designed either to support its mass in accordance with the requirements of para. 607 or shall be removable or otherwise rendered incapable of being used during transport.

609. As far as practicable, the *packaging* shall be so designed and finished that the external surfaces are free from protruding features and can be easily decontaminated.

610. As far as practicable, the outer layer of the *package* shall be so designed as to prevent the collection and the retention of water.

REQUIREMENTS FOR RADIOACTIVE MATERIALS

611. Any features added to the *package* at the time of transport which are not part of the *package* shall not reduce its safety.

612. The *package* shall be capable of withstanding the effects of any acceleration, vibration or vibration resonance which may arise under routine conditions of transport without any deterioration in the effectiveness of the closing devices on the various receptacles or in the integrity of the *package* as a whole. In particular, nuts, bolts and other securing devices shall be so designed as to prevent them from becoming loose or being released unintentionally, even after repeated use.

613. The materials of the *packaging* and any components or structures shall be physically and chemically compatible with each other and with the *radioactive contents*. Account shall be taken of their behaviour under irradiation.

614. All valves through which the *radioactive contents* could otherwise escape shall be protected against unauthorized operation.

615. The design of the *package* shall take into account ambient temperatures and pressures that are likely to be encountered in routine conditions of transport.

616. For *radioactive material* having other dangerous properties the *package design* shall take into account those properties; see paras 109 and 507.

ADDITIONAL REQUIREMENTS FOR PACKAGES TRANSPORTED BY AIR

617. For *packages* to be transported by air, the temperature of the accessible surfaces shall not exceed 50°C at an ambient temperature of 38°C with no account taken for insolation.

618. *Packages* to be transported by air shall be so designed that, if they were exposed to ambient temperatures ranging from -40°C to +55°C, the integrity of containment would not be impaired.

619. *Packages* containing *radioactive material* to be transported by air shall be capable of withstanding, without leakage, an internal pressure which produces a pressure differential of not less than *maximum normal operating pressure* plus 95 kPa.

SECTION VI

REQUIREMENTS FOR EXCEPTED PACKAGES

620. An *excepted package* shall be designed to meet the requirements specified in paras 606–616 and, in addition, the requirements of paras 617–619 if carried by air.

REQUIREMENTS FOR INDUSTRIAL PACKAGES

Requirements for Type IP-1

621. A *Type IP-1 package* shall be designed to meet the requirements specified in paras 606–616 and 634, and, in addition, the requirements of paras 617–619 if carried by air.

Requirements for Type IP-2

622. A *package* to be qualified as a *Type IP-2* shall be designed to meet the requirements for *Type IP-1* as specified in para. 621 and, in addition, if it were subjected to the tests specified in paras 722 and 723, it would prevent:

- (a) loss or dispersal of the *radioactive contents*; and
- (b) a more than 20% increase in the maximum *radiation level* at any external surface of the *package*.

Requirements for Type IP-3

623. A *package* to be qualified as a *Type IP-3* shall be designed to meet the requirements for *Type IP-1* as specified in para. 621 and, in addition, the requirements specified in paras 634–647.

Alternative requirements for Type IP-2 and Type IP-3

624. *Packages* may be used as *Type IP-2* provided that:

- (a) They satisfy the requirements for *Type IP-1* specified in para. 621;
- (b) They are designed to conform to the standards prescribed in the chapter on General Recommendations on Packing of the United Nations Recommendations on the Transport of Dangerous Goods [7], or other requirements at least equivalent to those standards; and

REQUIREMENTS FOR RADIOACTIVE MATERIALS

- (c) When subjected to the tests required for UN Packing Group I or II, they would prevent:
 - (i) loss or dispersal of the *radioactive contents*; and
 - (ii) more than a 20% increase in the maximum *radiation level* at the external surface of the *package*.

625. Tank containers may also be used as *Type IP-2* or *Type IP-3*, provided that:

- (a) They satisfy the requirements for *Type IP-1* specified in para. 621;
- (b) They are designed to conform to the standards prescribed in the chapter on Recommendations on Multimodal Tank Transport of the United Nations Recommendations on the Transport of Dangerous Goods [7], or other requirements at least equivalent to those standards, and are capable of withstanding a test pressure of 265 kPa; and
- (c) They are designed so that any additional shielding which is provided shall be capable of withstanding the static and dynamic stresses resulting from handling and routine conditions of transport and of preventing more than a 20% increase in the maximum *radiation level* at the external surface of the tank containers.

626. *Tanks*, other than tank containers, may also be used as *Type IP-2* or *Type IP-3* for transporting *LSA-I* and *LSA-II* liquids and gases as prescribed in Table 4, provided that they conform to standards at least equivalent to those prescribed in para. 625.

627. *Freight containers* may also be used as *Type IP-2* or *Type IP-3*, provided that:

- (a) The *radioactive contents* are restricted to solid materials;
- (b) They satisfy the requirements for *Type IP-1* specified in para. 621; and
- (c) They are designed to conform to the standards prescribed in the International Organization for Standardization document ISO 1496/1: “Series 1 Freight Containers — Specifications and Testing — Part 1: General Cargo Containers” [9] excluding dimensions and ratings. They shall be designed such that if subjected to the tests prescribed in that document and to the accelerations occurring during routine conditions of transport they would prevent:
 - (i) loss or dispersal of the *radioactive contents*; and
 - (ii) more than a 20% increase in the maximum *radiation level* at the external surface of the *freight containers*.

SECTION VI

628. Metal *intermediate bulk containers* may also be used as *Type IP-2* or *Type IP-3*, provided that:

- (a) They satisfy the requirements for *Type IP-1* specified in para. 621; and
- (b) They are designed to conform to the standards prescribed in the chapter on Recommendations on Intermediate Bulk Containers (IBCs) of the United Nations Recommendations on the Transport of Dangerous Goods [7], for Packing Group I or II, and if they were subjected to the tests prescribed in that document, but with the drop test conducted in the most damaging orientation, they would prevent:
 - (i) loss or dispersal of the *radioactive contents*; and
 - (ii) more than a 20% increase in the maximum *radiation level* at the external surface of the *intermediate bulk container*.

REQUIREMENTS FOR PACKAGES CONTAINING URANIUM HEXAFLUORIDE

629. *Packages* designed to contain uranium hexafluoride shall meet the requirements prescribed elsewhere in these Regulations which pertain to the radioactive and fissile properties of the material. Except as allowed in para. 632, uranium hexafluoride in quantities of 0.1 kg or more shall also be packaged and transported in accordance with the provisions of the International Organization for Standardization document ISO 7195: "Packaging of Uranium Hexafluoride (UF₆) for Transport" [10], and the requirements of paras 630–631.

630. Each *package* designed to contain 0.1 kg or more of uranium hexafluoride shall be designed so that it would meet the following requirements:

- (a) withstand without leakage and without unacceptable stress, as specified in the International Organization for Standardization document ISO 7195 [10], the structural test as specified in para. 718;
- (b) withstand without loss or dispersal of the uranium hexafluoride the free drop test specified in para. 722; and
- (c) withstand without rupture of the *containment system* the thermal test specified in para. 728.

631. *Packages* designed to contain 0.1 kg or more of uranium hexafluoride shall not be provided with pressure relief devices.

REQUIREMENTS FOR RADIOACTIVE MATERIALS

632. Subject to the approval of the *competent authority*, *packages* designed to contain 0.1 kg or more of uranium hexafluoride may be transported if:

- (a) the *packages* are designed to international or national standards other than ISO 7195 [10], provided an equivalent level of safety is maintained;
- (b) the *packages* are designed to withstand without leakage and without unacceptable stress a test pressure of less than 2.76 MPa as specified in para. 718; or
- (c) for *packages* designed to contain 9000 kg or more of uranium hexafluoride, the *packages* do not meet the requirement of para. 630(c).

In all other respects the requirements specified in paras 629–631 shall be satisfied.

REQUIREMENTS FOR TYPE A PACKAGES

633. *Type A packages* shall be designed to meet the requirements specified in paras 606–616 and, in addition, the requirements of paras 617–619 if carried by air, and of paras 634–649.

634. The smallest overall external dimension of the *package* shall not be less than 10 cm.

635. The outside of the *package* shall incorporate a feature such as a seal which is not readily breakable and which, while intact, will be evidence that the package has not been opened.

636. Any tie-down attachments on the *package* shall be so designed that, under normal and accident conditions of transport, the forces in those attachments shall not impair the ability of the *package* to meet the requirements of these Regulations.

637. The *design* of the *package* shall take into account temperatures ranging from -40°C to $+70^{\circ}\text{C}$ for the components of the *packaging*. Attention shall be given to freezing temperatures for liquids and to the potential degradation of *packaging* materials within the given temperature range.

638. The *design* and manufacturing techniques shall be in accordance with national or international standards, or other requirements, acceptable to the *competent authority*.

SECTION VI

639. The *design* shall include a *containment system* securely closed by a positive fastening device which cannot be opened unintentionally or by a pressure which may arise within the *package*.

640. *Special form radioactive material* may be considered as a component of the *containment system*.

641. If the *containment system* forms a separate unit of the *package*, it shall be capable of being securely closed by a positive fastening device which is independent of any other part of the *packaging*.

642. The *design* of any component of the *containment system* shall take into account, where applicable, the radiolytic decomposition of liquids and other vulnerable materials and the generation of gas by chemical reaction and radiolysis.

643. The *containment system* shall retain its *radioactive contents* under a reduction of ambient pressure to 60 kPa.

644. All valves, other than pressure relief valves, shall be provided with an enclosure to retain any leakage from the valve.

645. A radiation shield which encloses a component of the *package* specified as a part of the *containment system* shall be so designed as to prevent the unintentional release of that component from the shield. Where the radiation shield and such component within it form a separate unit, the radiation shield shall be capable of being securely closed by a positive fastening device which is independent of any other *packaging* structure.

646. A *package* shall be so designed that, if it were subjected to the tests specified in paras 719–724, it would prevent:

- (a) Loss or dispersal of the *radioactive contents*; and
- (b) More than a 20% increase in the maximum *radiation level* at the external surface of the *package*.

647. The *design* of a *package* intended for liquid *radioactive material* shall make provision for ullage to accommodate variations in the temperature of the contents, dynamic effects and filling dynamics.

REQUIREMENTS FOR RADIOACTIVE MATERIALS

648. A *Type A package* designed to contain liquid radioactive material shall, in addition:

- (a) Be adequate to meet the conditions specified in para. 646(a) if the *package* is subjected to the tests specified in para. 725; and
- (b) Either
 - (i) Be provided with sufficient absorbent material to absorb twice the volume of the liquid contents. Such absorbent material must be suitably positioned so as to contact the liquid in the event of leakage; or
 - (ii) Be provided with a *containment system* composed of primary inner and secondary outer containment components designed to ensure retention of the liquid contents, within the secondary outer containment components, even if the primary inner components leak.

649. A *package* designed for gases shall prevent loss or dispersal of the *radioactive contents* if the *package* were subjected to the tests specified in para. 725. A *Type A package* designed for tritium gas or for noble gases shall be excepted from this requirement.

REQUIREMENTS FOR TYPE B(U) PACKAGES

650. *Type B(U) packages* shall be designed to meet the requirements specified in paras 606–616, the requirements of paras 617–619 if carried by air, and of paras 634–647, except as specified in para. 646(a), and, in addition, the requirements specified in paras 651–664.

651. A *package* shall be so designed that, under the ambient conditions specified in paras 654 and 655, heat generated within the *package* by the *radioactive contents* shall not, under normal conditions of transport, as demonstrated by the tests in paras 719–724, adversely affect the *package* in such a way that it would fail to meet the applicable requirements for containment and shielding if left unattended for a period of one week. Particular attention shall be paid to the effects of heat, which may:

- (a) Alter the arrangement, the geometrical form or the physical state of the *radioactive contents* or, if the *radioactive material* is enclosed in a can or receptacle (for example, clad fuel elements), cause the can, receptacle or *radioactive material* to deform or melt; or

SECTION VI

- (b) Lessen the efficiency of the *packaging* through differential thermal expansion, or cracking or melting of the radiation shielding material; or
- (c) In combination with moisture, accelerate corrosion.

652. A *package* shall be so designed that, under the ambient condition specified in para. 654 and in the absence of insolation, the temperature of the accessible surfaces of a *package* shall not exceed 50°C, unless the package is transported under *exclusive use*.

653. Except as required in para. 617 for a *package* transported by air, the maximum temperature of any surface readily accessible during transport of a *package* under exclusive use shall not exceed 85°C in the absence of insolation under the ambient conditions specified in para. 654. Account may be taken of barriers or screens intended to give protection to persons without the need for the barriers or screens being subject to any test.

654. The ambient temperature shall be assumed to be 38°C.

655. The solar insolation conditions shall be assumed to be as specified in Table 11.

656. A *package* which includes thermal protection for the purpose of satisfying the requirements of the thermal test specified in para. 728 shall be so designed that such protection will remain effective if the *package* is subjected to the tests specified in paras 719–724 and 727(a) and (b) or 727(b) and (c), as appropriate. Any such protection on the exterior of the *package* shall not be rendered ineffective by ripping, cutting, skidding, abrasion or rough handling.

TABLE 11. INSOLATION DATA

Case	Form and location of surface	Insolation for 12 hours per day (W/m ²)
1	Flat surfaces transported horizontally — downward facing	0
2	Flat surfaces transported horizontally — upward facing	800
3	Surfaces transported vertically	200 ^a
4	Other downward facing (not horizontal) surfaces	200 ^a
5	All other surfaces	400 ^a

^a Alternatively, a sine function may be used, with an absorption coefficient adopted and the effects of possible reflection from neighbouring objects neglected.

REQUIREMENTS FOR RADIOACTIVE MATERIALS

657. A *package* shall be so designed that, if it were subjected to:

- (a) The tests specified in paras 719–724, it would restrict the loss of *radioactive contents* to not more than $10^{-6}A_2$ per hour; and
- (b) The tests specified in paras 726, 727(b), 728 and 729 and the tests in paras:
 - (i) 727(c), when the *package* has a mass not greater than 500 kg, an overall density not greater than 1000 kg/m^3 based on the external dimensions, and *radioactive contents* greater than $1000A_2$ not as *special form radioactive material*, or
 - (ii) 727(a), for all other *packages*,
it would meet the following requirements:
 - (i) retain sufficient shielding to ensure that the *radiation level* at 1 m from the surface of the *package* would not exceed 10 mSv/h with the maximum *radioactive contents* which the *package* is designed to contain; and
 - (ii) restrict the accumulated loss of *radioactive contents* in a period of one week to not more than $10A_2$ for krypton-85 and not more than A_2 for all other radionuclides.

Where mixtures of different radionuclides are present, the provisions of paras 404–406 shall apply except that for krypton-85 an effective $A_2(i)$ value equal to $10A_2$ may be used. For case (a) above, the assessment shall take into account the external *contamination* limits of para. 508.

658. A *package* for *radioactive contents* with activity greater than 10^5A_2 shall be so designed that, if it were subjected to the enhanced water immersion test specified in para. 730, there would be no rupture of the *containment system*.

659. Compliance with the permitted activity release limits shall depend neither upon filters nor upon a mechanical cooling system.

660. A *package* shall not include a pressure relief system from the *containment system* which would allow the release of *radioactive material* to the environment under the conditions of the tests specified in paras 719–724 and 726–729.

661. A *package* shall be so designed that if it were at the *maximum normal operating pressure* and it were subjected to the tests specified in paras 719–724 and 726–729, the level of strains in the *containment system* would not attain values which would adversely affect the *package* in such a way that it would fail to meet the applicable requirements.

SECTION VI

662. A *package* shall not have a *maximum normal operating pressure* in excess of a gauge pressure of 700 kPa.

663. A *package* containing *low dispersible radioactive material* shall be so designed that any features added to the *low dispersible radioactive material* that are not part of it, or any internal components of the *packaging*, shall not adversely affect the performance of the *low dispersible radioactive material*.

664. A *package* shall be designed for an ambient temperature range from -40°C to $+38^{\circ}\text{C}$.

REQUIREMENTS FOR TYPE B(M) PACKAGES

665. *Type B(M) packages* shall meet the requirements for *Type B(U) packages* specified in para. 650, except that for *packages* to be transported solely within a specified country or solely between specified countries, conditions other than those given in paras 637, 653–655 and 658–664 above may be assumed with the approval of the *competent authorities* of these countries. Notwithstanding, the requirements for *Type B(U) packages* specified in paras 653 and 658–664 shall be met as far as practicable.

666. Intermittent venting of *Type B(M) packages* may be permitted during transport, provided that the operational controls for venting are acceptable to the relevant *competent authorities*.

REQUIREMENTS FOR TYPE C PACKAGES

667. *Type C packages* shall be designed to meet the requirements specified in paras 606–619, and of paras 634–647, except as specified in para. 646(a), and of the requirements specified in paras 651–655, 659–664, and, in addition, of paras 668–670.

668. A *package* shall be capable of meeting the assessment criteria prescribed for tests in paras 657(b) and 661 after burial in an environment defined by a thermal conductivity of $0.33 \text{ W}/(\text{m}\cdot\text{K})$ and a temperature of 38°C in the steady state. Initial conditions for the assessment shall assume that any thermal insulation of the *package* remains intact, the *package* is at the *maximum normal operating pressure* and the ambient temperature is 38°C .

REQUIREMENTS FOR RADIOACTIVE MATERIALS

669. A *package* shall be so designed that, if it were at the *maximum normal operating pressure* and subjected to:

- (a) the tests specified in paras 719–724, it would restrict the loss of *radioactive contents* to not more than $10^{-6}A_2$ per hour; and
- (b) the test sequences in para. 734, it would meet the following requirements:
 - (i) retain sufficient shielding to ensure that the *radiation level* at 1 m from the surface of the *package* would not exceed 10 mSv/h with the maximum *radioactive contents* which the *package* is designed to contain; and
 - (ii) restrict the accumulated loss of *radioactive contents* in a period of one week to not more than $10A_2$ for krypton-85 and not more than A_2 for all other radionuclides.

Where mixtures of different radionuclides are present, the provisions of paras 404–406 shall apply, except that for krypton-85 an effective $A_2(i)$ value equal to $10A_2$ may be used. For case (a) above, the assessment shall take into account the external *contamination* limits of para. 508.

670. A *package* shall be so designed that there will be no rupture of the *containment system* following performance of the enhanced water immersion test specified in para. 730.

REQUIREMENTS FOR PACKAGES CONTAINING FISSILE MATERIAL

671. *Fissile material* shall be transported so as to:

- (a) maintain subcriticality during normal and accident conditions of transport; in particular, the following contingencies shall be considered:
 - (i) water leaking into or out of *packages*;
 - (ii) the loss of efficiency of built-in neutron absorbers or moderators;
 - (iii) rearrangement of the contents either within the *package* or as a result of loss from the *package*;
 - (iv) reduction of spaces within or between *packages*;
 - (v) *packages* becoming immersed in water or buried in snow; and
 - (vi) temperature changes; and

SECTION VI

- (b) meet the requirements:
 - (i) of para. 634 for *packages* containing *fissile material*;
 - (ii) prescribed elsewhere in these Regulations which pertain to the radioactive properties of the material; and
 - (iii) specified in paras 673–682, unless excepted by para. 672.

Exceptions from the requirements for packages containing fissile material

672. *Fissile material* meeting one of the provisions (a)–(d) of this paragraph is excepted from the requirement to be transported in *packages* that comply with paras 673–682 as well as the other requirements of these Regulations that apply to *fissile material*. Only one type of exception is allowed per *consignment*:

- (a) A mass limit per *consignment* such that:

$$\frac{\text{mass of uranium-235 (g)}}{X} + \frac{\text{mass of other fissile material (g)}}{Y} < 1$$

where X and Y are the mass limits defined in Table 12, provided that the smallest external dimension of each package is not less than 10 cm and that either:

- (i) each individual *package* contains not more than 15 g of *fissile material*; for unpackaged material, this quantity limitation shall apply to the *consignment* being carried in or on the *conveyance*; or
- (ii) the *fissile material* is a homogeneous hydrogenous solution or mixture where the ratio of fissile nuclides to hydrogen is less than 5% by mass; or
- (iii) there are not more than 5 g of *fissile material* in any 10 litre volume of material.

Neither beryllium nor deuterium shall be present in quantities exceeding 1% of the applicable *consignment* mass limits provided in Table 12, except for deuterium in natural concentration in hydrogen.

- (b) Uranium enriched in uranium-235 to a maximum of 1% by mass, and with a total plutonium and uranium-233 content not exceeding 1% of the mass of uranium-235, provided that the *fissile material* is distributed essentially homogeneously throughout the material. In addition, if uranium-235 is present in metallic, oxide or carbide forms, it shall not form a lattice arrangement.

REQUIREMENTS FOR RADIOACTIVE MATERIALS

TABLE 12. CONSIGNMENT MASS LIMITS FOR EXCEPTIONS FROM THE REQUIREMENTS FOR PACKAGES CONTAINING FISSILE MATERIAL

<i>Fissile material</i>	<i>Fissile material</i> mass (g) mixed with substances having an average hydrogen density less than or equal to water	<i>Fissile material</i> mass (g) mixed with substances having an average hydrogen density greater than water
Uranium-235 (X)	400	290
Other <i>fissile material</i> (Y)	250	180

- (c) Liquid solutions of uranyl nitrate enriched in uranium-235 to a maximum of 2% by mass, with a total plutonium and uranium-233 content not exceeding 0.002% of the mass of uranium, and with a minimum nitrogen to uranium atomic ratio (N/U) of 2.
- (d) *Packages* containing, individually, a total plutonium mass not more than 1 kg, of which not more than 20% by mass may consist of plutonium-239, plutonium-241 or any combination of those radionuclides.

Contents specification for assessments of packages containing fissile material

673. Where the chemical or physical form, isotopic composition, mass or concentration, moderation ratio or density, or geometric configuration is not known, the assessments of paras 677–682 shall be performed assuming that each parameter that is not known has the value which gives the maximum neutron multiplication consistent with the known conditions and parameters in these assessments.

674. For irradiated nuclear fuel the assessments of paras 677–682 shall be based on an isotopic composition demonstrated to provide:

- (a) the maximum neutron multiplication during the irradiation history, or
- (b) a conservative estimate of the neutron multiplication for the *package* assessments. After irradiation but prior to *shipment*, a measurement shall be performed to confirm the conservatism of the isotopic composition.

Geometry and temperature requirements

675. The *package*, after being subjected to the tests specified in paras 719–724, must prevent the entry of a 10 cm cube.

SECTION VI

676. The *package* shall be designed for an ambient temperature range of -40°C to $+38^{\circ}\text{C}$ unless the *competent authority* specifies otherwise in the certificate of approval for the *package design*.

Assessment of an individual package in isolation

677. For a *package* in isolation, it shall be assumed that water can leak into or out of all void spaces of the *package*, including those within the *containment system*. However, if the *design* incorporates special features to prevent such leakage of water into or out of certain void spaces, even as a result of error, absence of leakage may be assumed in respect of those void spaces. Special features shall include the following:

- (a) Multiple high standard water barriers, each of which would remain watertight if the *package* were subject to the tests prescribed in para. 682(b), a high degree of quality control in the manufacture, maintenance and repair of *packagings*, and tests to demonstrate the closure of each *package* before each *shipment*; or
- (b) For *packages* containing uranium hexafluoride only, with maximum uranium enrichment of 5 mass per cent uranium-235:
 - (i) *packages* where, following the tests prescribed in para. 682(b), there is no physical contact between the valve and any other component of the *packaging* other than at its original point of attachment and where, in addition, following the test prescribed in para. 728 the valves remain leaktight; and
 - (ii) a high degree of quality control in the manufacture, maintenance and repair of *packagings*, coupled with tests to demonstrate closure of each *package* before each *shipment*.

678. It shall be assumed that the *confinement system* shall be closely reflected by at least 20 cm of water or such greater reflection as may additionally be provided by the surrounding material of the *packaging*. However, when it can be demonstrated that the *confinement system* remains within the *packaging* following the tests prescribed in para. 682(b), close reflection of the *package* by at least 20 cm of water may be assumed in para. 679(c).

679. The *package* shall be subcritical under the conditions of paras 677 and 678 with the *package* conditions that result in the maximum neutron multiplication consistent with:

REQUIREMENTS FOR RADIOACTIVE MATERIALS

- (a) routine conditions of transport (incident free);
- (b) the tests specified in para. 681(b);
- (c) the tests specified in para. 682(b).

680. For *packages* to be transported by air:

- (a) the *package* shall be subcritical under conditions consistent with the Type C package tests specified in para. 734 assuming reflection by at least 20 cm of water but no water in-leakage; and
- (b) in the assessment of para. 679 allowance shall not be made for special features of para. 677 unless, following the Type C package tests specified in para. 734 and, subsequently, the water in-leakage test of para. 733, leakage of water into or out of the void spaces is prevented.

Assessment of package arrays under normal conditions of transport

681. A number “N” shall be derived, such that five times “N” packages shall be subcritical for the arrangement and *package* conditions that provide the maximum neutron multiplication consistent with the following:

- (a) There shall not be anything between the *packages*, and the *package* arrangement shall be reflected on all sides by at least 20 cm of water; and
- (b) The state of the *packages* shall be their assessed or demonstrated condition if they had been subjected to the tests specified in paras 719–724.

Assessment of package arrays under accident conditions of transport

682. A number “N” shall be derived, such that two times “N” packages shall be subcritical for the arrangement and *package* conditions that provide the maximum neutron multiplication consistent with the following:

- (a) Hydrogenous moderation between *packages*, and the *package* arrangement reflected on all sides by at least 20 cm of water; and
- (b) The tests specified in paras 719–724 followed by whichever of the following is the more limiting:
 - (i) the tests specified in para. 727(b), and either para. 727(c) for *packages* having a mass not greater than 500 kg and an overall density not greater than 1000 kg/m³ based on the external dimensions, or para. 727(a) for all other *packages*; followed by the

SECTION VI

- test specified in para. 728 and completed by the tests specified in paras 731–733; or
- (ii) the test specified in para. 729; and
 - (c) Where any part of the *fissile material* escapes from the *containment system* following the tests specified in para. 682(b), it shall be assumed that *fissile material* escapes from each *package* in the array, and all of the *fissile material* shall be arranged in the configuration and moderation that results in the maximum neutron multiplication with close reflection by at least 20 cm of water.

Section VII

TEST PROCEDURES

DEMONSTRATION OF COMPLIANCE

701. Demonstration of compliance with the performance standards required in Section VI shall be accomplished by any of the methods listed below or by a combination thereof.

- (a) Performance of tests with specimens representing *LSA-III material*, or *special form radioactive material*, or *low dispersible radioactive material* or with prototypes or samples of the *packaging*, where the contents of the specimen or the *packaging* for the tests shall simulate as closely as practicable the expected range of *radioactive contents* and the specimen or *packaging* to be tested shall be prepared as presented for transport.
- (b) Reference to previous satisfactory demonstrations of a sufficiently similar nature.
- (c) Performance of tests with models of appropriate scale incorporating those features which are significant with respect to the item under investigation when engineering experience has shown results of such tests to be suitable for design purposes. When a scale model is used, the need for adjusting certain test parameters, such as penetrator diameter or compressive load, shall be taken into account.
- (d) Calculation, or reasoned argument, when the calculation procedures and parameters are generally agreed to be reliable or conservative.

702. After the specimen, prototype or sample has been subjected to the tests, appropriate methods of assessment shall be used to ensure that the requirements of this section have been fulfilled in compliance with the performance and acceptance standards prescribed in Section VI.

LEACHING TEST FOR LSA-III MATERIAL AND LOW DISPERSIBLE RADIOACTIVE MATERIAL

703. A solid material sample representing the entire contents of the *package* shall be immersed for 7 days in water at ambient temperature. The volume of water to be used in the test shall be sufficient to ensure that at the end of the

SECTION VII

7 day test period the free volume of the unabsorbed and unreacted water remaining shall be at least 10% of the volume of the solid test sample itself. The water shall have an initial pH of 6–8 and a maximum conductivity of 1 mS/m at 20°C. The total activity of the free volume of water shall be measured following the 7 day immersion of the test sample.

TESTS FOR SPECIAL FORM RADIOACTIVE MATERIAL

General

704. Specimens that comprise or simulate *special form radioactive material* shall be subjected to the impact test, the percussion test, the bending test and the heat test specified in paras 705–709. A different specimen may be used for each of the tests. Following each test, a leaching assessment or volumetric leakage test shall be performed on the specimen by a method no less sensitive than the methods given in para. 710 for indispersible solid material or in para. 711 for encapsulated material.

Test methods

705. Impact test: The specimen shall drop onto the target from a height of 9 m. The target shall be as defined in para. 717.

706. Percussion test: The specimen shall be placed on a sheet of lead which is supported by a smooth solid surface and struck by the flat face of a mild steel bar so as to cause an impact equivalent to that resulting from a free drop of 1.4 kg through 1 m. The lower part of the bar shall be 25 mm in diameter with the edges rounded off to a radius of (3.0 ± 0.3) mm. The lead, of hardness number 3.5 to 4.5 on the Vickers scale and not more than 25 mm thick, shall cover an area greater than that covered by the specimen. A fresh surface of lead shall be used for each impact. The bar shall strike the specimen so as to cause maximum damage.

707. Bending test: The test shall apply only to long, slender sources with both a minimum length of 10 cm and a length to minimum width ratio of not less than 10. The specimen shall be rigidly clamped in a horizontal position so that one half of its length protrudes from the face of the clamp. The orientation of the specimen shall be such that the specimen will suffer maximum damage when its free end is struck by the flat face of a steel bar. The bar shall strike the specimen so as to cause an impact equivalent to that resulting from a free

TEST PROCEDURES

vertical drop of 1.4 kg through 1 m. The lower part of the bar shall be 25 mm in diameter with the edges rounded off to a radius of (3.0 ± 0.3) mm.

708. Heat test: The specimen shall be heated in air to a temperature of 800°C and held at that temperature for a period of 10 minutes and shall then be allowed to cool.

709. Specimens that comprise or simulate *radioactive material* enclosed in a sealed capsule may be excepted from:

- (a) The tests prescribed in paras 705 and 706 provided the mass of the *special form radioactive material*
 - (i) is less than 200 g and they are alternatively subjected to the Class 4 impact test prescribed in the International Organization for Standardization document ISO 2919: “Sealed Radioactive Sources – Classification” [11], or
 - (ii) is less than 500 g and they are alternatively subjected to the Class 5 impact test prescribed in the International Organization for Standardization document ISO 2919: “Sealed Radioactive Sources – Classification” [11], and
- (b) The test prescribed in para. 708 provided they are alternatively subjected to the Class 6 temperature test specified in the International Organization for Standardization document ISO 2919: “Sealed Radioactive Sources – Classification” [11].

Leaching and volumetric leakage assessment methods

710. For specimens which comprise or simulate indispersible solid material, a leaching assessment shall be performed as follows:

- (a) The specimen shall be immersed for 7 days in water at ambient temperature. The volume of water to be used in the test shall be sufficient to ensure that at the end of the 7 day test period the free volume of the unabsorbed and unreacted water remaining shall be at least 10% of the volume of the solid test sample itself. The water shall have an initial pH of 6–8 and a maximum conductivity of 1 mS/m at 20°C.
- (b) The water with specimen shall then be heated to a temperature of (50 ± 5) °C and maintained at this temperature for 4 hours.
- (c) The activity of the water shall then be determined.
- (d) The specimen shall then be kept for at least 7 days in still air at not less than 30°C and a relative humidity not less than 90%.

SECTION VII

- (e) The specimen shall then be immersed in water of the same specification as in (a) above and the water with the specimen heated to $(50 \pm 5)^{\circ}\text{C}$ and maintained at this temperature for 4 hours.
- (f) The activity of the water shall then be determined.

711. For specimens which comprise or simulate *radioactive material* enclosed in a sealed capsule, either a leaching assessment or a volumetric leakage assessment shall be performed as follows:

- (a) The leaching assessment shall consist of the following steps:
 - (i) The specimen shall be immersed in water at ambient temperature. The water shall have an initial pH of 6–8 with a maximum conductivity of 1 mS/m at 20°C .
 - (ii) The water and specimen shall be heated to a temperature of $(50 \pm 5)^{\circ}\text{C}$ and maintained at this temperature for 4 hours.
 - (iii) The activity of the water shall then be determined.
 - (iv) The specimen shall then be kept for at least 7 days in still air at not less than 30°C and a relative humidity of not less than 90%.
 - (v) The process in (i), (ii) and (iii) shall be repeated.
- (b) The alternative volumetric leakage assessment shall comprise any of the tests prescribed in the International Organization for Standardization document ISO 9978: “Radiation Protection — Sealed Radioactive Sources — Leakage Test Methods” [8] which are acceptable to the *competent authority*.

TESTS FOR LOW DISPERSIBLE RADIOACTIVE MATERIAL

712. A specimen that comprises or simulates *low dispersible radioactive material* shall be subjected to the enhanced thermal test specified in para. 736 and the impact test specified in para. 737. A different specimen may be used for each of the tests. Following each test, the specimen shall be subjected to the leach test specified in para. 703. After each test it shall be determined if the applicable requirements of para. 605 have been met.

TEST PROCEDURES

TESTS FOR PACKAGES

Preparation of a specimen for testing

713. All specimens shall be inspected before testing in order to identify and record faults or damage including the following:

- (a) divergence from the *design*;
- (b) defects in manufacture;
- (c) corrosion or other deterioration; and
- (d) distortion of features.

714. The *containment system* of the *package* shall be clearly specified.

715. The external features of the specimen shall be clearly identified so that reference may be made simply and clearly to any part of such a specimen.

Testing the integrity of the containment system and shielding and assessing criticality safety

716. After each of the applicable tests specified in paras 718–737:

- (a) Faults and damage shall be identified and recorded;
- (b) It shall be determined whether the integrity of the *containment system* and shielding has been retained to the extent required in Section VI for the *package* under test; and
- (c) For *packages* containing *fissile material*, it shall be determined whether the assumptions and conditions used in the assessments required by paras 671–682 for one or more *packages* are valid.

Target for drop tests

717. The target for the drop test specified in paras 705, 722, 725(a), 727 and 735 shall be a flat, horizontal surface of such a character that any increase in its resistance to displacement or deformation upon impact by the specimen would not significantly increase damage to the specimen.

Test for packagings designed to contain uranium hexafluoride

718. Specimens that comprise or simulate *packagings* designed to contain 0.1 kg or more of uranium hexafluoride shall be tested hydraulically at an

SECTION VII

internal pressure of at least 1.38 MPa but, when the test pressure is less than 2.76 MPa, the *design* shall require *multilateral approval*. For retesting *packagings*, any other equivalent non-destructive testing may be applied subject to *multilateral approval*.

Tests for demonstrating ability to withstand normal conditions of transport

719. The tests are: the water spray test, the free drop test, the stacking test and the penetration test. Specimens of the *package* shall be subjected to the free drop test, the stacking test and the penetration test, preceded in each case by the water spray test. One specimen may be used for all the tests, provided that the requirements of para. 720 are fulfilled.

720. The time interval between the conclusion of the water spray test and the succeeding test shall be such that the water has soaked in to the maximum extent, without appreciable drying of the exterior of the specimen. In the absence of any evidence to the contrary, this interval shall be taken to be two hours if the water spray is applied from four directions simultaneously. No time interval shall elapse, however, if the water spray is applied from each of the four directions consecutively.

721. Water spray test: The specimen shall be subjected to a water spray test that simulates exposure to rainfall of approximately 5 cm per hour for at least one hour.

722. Free drop test: The specimen shall drop onto the target so as to suffer maximum damage in respect of the safety features to be tested.

- (a) The height of drop measured from the lowest point of the specimen to the upper surface of the target shall be not less than the distance specified in Table 13 for the applicable mass. The target shall be as defined in para. 717.
- (b) For rectangular fibreboard or wood *packages* not exceeding a mass of 50 kg, a separate specimen shall be subjected to a free drop onto each corner from a height of 0.3 m.
- (c) For cylindrical fibreboard *packages* not exceeding a mass of 100 kg, a separate specimen shall be subjected to a free drop onto each of the quarters of each rim from a height of 0.3 m.

TEST PROCEDURES

TABLE 13. FREE DROP DISTANCE FOR TESTING PACKAGES TO NORMAL CONDITIONS OF TRANSPORT

Package mass (kg)	Free drop distance (m)
$Package\ mass < 5\ 000$	1.2
$5\ 000 \leq Package\ mass < 10\ 000$	0.9
$10\ 000 \leq Package\ mass < 15\ 000$	0.6
$15\ 000 \leq Package\ mass$	0.3

723. Stacking test: Unless the shape of the *packaging* effectively prevents stacking, the specimen shall be subjected, for a period of 24 h, to a compressive load equal to the greater of the following:

- (a) The equivalent of 5 times the mass of the actual *package*; and
- (b) The equivalent of 13 kPa multiplied by the vertically projected area of the *package*.

The load shall be applied uniformly to two opposite sides of the specimen, one of which shall be the base on which the *package* would typically rest.

724. Penetration test: The specimen shall be placed on a rigid, flat, horizontal surface which will not move significantly while the test is being carried out.

- (a) A bar of 3.2 cm in diameter with a hemispherical end and a mass of 6 kg shall be dropped and directed to fall, with its longitudinal axis vertical, onto the centre of the weakest part of the specimen, so that, if it penetrates sufficiently far, it will hit the *containment system*. The bar shall not be significantly deformed by the test performance.
- (b) The height of drop of the bar measured from its lower end to the intended point of impact on the upper surface of the specimen shall be 1 m.

Additional tests for Type A packages designed for liquids and gases

725. A specimen or separate specimens shall be subjected to each of the following tests unless it can be demonstrated that one test is more severe for the specimen in question than the other, in which case one specimen shall be subjected to the more severe test.

SECTION VII

- (a) Free drop test: The specimen shall drop onto the target so as to suffer the maximum damage in respect of containment. The height of the drop measured from the lowest part of the specimen to the upper surface of the target shall be 9 m. The target shall be as defined in para. 717.
- (b) Penetration test: The specimen shall be subjected to the test specified in para. 724 except that the height of drop shall be increased to 1.7 m from the 1 m specified in para. 724(b).

Tests for demonstrating ability to withstand accident conditions of transport

726. The specimen shall be subjected to the cumulative effects of the tests specified in para. 727 and para. 728, in that order. Following these tests, either this specimen or a separate specimen shall be subjected to the effect(s) of the water immersion test(s) as specified in para. 729 and, if applicable, para. 730.

727. Mechanical test: The mechanical test consists of three different drop tests. Each specimen shall be subjected to the applicable drops as specified in para. 657 or para. 682. The order in which the specimen is subjected to the drops shall be such that, on completion of the mechanical test, the specimen shall have suffered such damage as will lead to maximum damage in the thermal test which follows:

- (a) For drop I, the specimen shall drop onto the target so as to suffer maximum damage, and the height of the drop measured from the lowest point of the specimen to the upper surface of the target shall be 9 m. The target shall be as defined in para. 717.
- (b) For drop II, the specimen shall drop so as to suffer maximum damage onto a bar rigidly mounted perpendicularly on the target. The height of the drop measured from the intended point of impact of the specimen to the upper surface of the bar shall be 1 m. The bar shall be of solid mild steel of circular section, (15.0 ± 0.5) cm in diameter and 20 cm long unless a longer bar would cause greater damage, in which case a bar of sufficient length to cause maximum damage shall be used. The upper end of the bar shall be flat and horizontal with its edge rounded off to a radius of not more than 6 mm. The target on which the bar is mounted shall be as described in para. 717.
- (c) For drop III, the specimen shall be subjected to a dynamic crush test by positioning the specimen on the target so as to suffer maximum damage by the drop of a 500 kg mass from 9 m onto the specimen. The mass shall consist of a solid mild steel plate 1 m by 1 m and shall fall in a horizontal attitude. The height of the drop shall be measured from the underside of

TEST PROCEDURES

the plate to the highest point of the specimen. The target on which the specimen rests shall be as defined in para. 717.

728. Thermal test: The specimen shall be in thermal equilibrium under conditions of an ambient temperature of 38°C, subject to the solar insolation conditions specified in Table 11 and subject to the *design* maximum rate of internal heat generation within the *package* from the *radioactive contents*. Alternatively, any of these parameters are allowed to have different values prior to and during the test, provided due account is taken of them in the subsequent assessment of *package* response.

The thermal test shall then consist of:

- (a) Exposure of a specimen for a period of 30 minutes to a thermal environment which provides a heat flux at least equivalent to that of a hydrocarbon fuel/air fire in sufficiently quiescent ambient conditions to give a minimum average flame emissivity coefficient of 0.9 and an average temperature of at least 800°C, fully engulfing the specimen, with a surface absorptivity coefficient of 0.8 or that value which the *package* may be demonstrated to possess if exposed to the fire specified, followed by
- (b) Exposure of the specimen to an ambient temperature of 38°C, subject to the solar insolation conditions specified in Table 11 and subject to the design maximum rate of internal heat generation within the *package* by the *radioactive contents* for a sufficient period to ensure that temperatures in the specimen are everywhere decreasing and/or are approaching initial steady state conditions. Alternatively, any of these parameters are allowed to have different values following cessation of heating, provided due account is taken of them in the subsequent assessment of *package* response.

During and following the test the specimen shall not be artificially cooled and any combustion of materials of the specimen shall be permitted to proceed naturally.

729. Water immersion test: The specimen shall be immersed under a head of water of at least 15 m for a period of not less than eight hours in the attitude which will lead to maximum damage. For demonstration purposes, an external gauge pressure of at least 150 kPa shall be considered to meet these conditions.

SECTION VII

Enhanced water immersion test for Type B(U) and Type B(M) packages containing more than $10^5 A_2$ and Type C packages

730. Enhanced water immersion test: The specimen shall be immersed under a head of water of at least 200 m for a period of not less than one hour. For demonstration purposes, an external gauge pressure of at least 2 MPa shall be considered to meet these conditions.

Water leakage test for packages containing fissile material

731. *Packages* for which water in-leakage or out-leakage to the extent which results in greatest reactivity has been assumed for purposes of assessment under paras 677–682 shall be excepted from the test.

732. Before the specimen is subjected to the water leakage test specified below, it shall be subjected to the tests in para. 727(b), and either para. 727(a) or (c) as required by para. 682, and the test specified in para. 728.

733. The specimen shall be immersed under a head of water of at least 0.9 m for a period of not less than eight hours and in the attitude for which maximum leakage is expected.

Tests for Type C packages

734. Specimens shall be subjected to the effects of each of the following test sequences in the orders specified:

- (a) the tests specified in paras 727(a), 727(c), 735 and 736; and
- (b) the test specified in para. 737.

Separate specimens are allowed to be used for each of the sequences (a) and (b).

735. Puncture/tearing test: The specimen shall be subjected to the damaging effects of a solid probe made of mild steel. The orientation of the probe to the surface of the specimen shall be such as to cause maximum damage at the conclusion of the test sequence specified in para. 734(a):

- (a) The specimen, representing a *package* having a mass of less than 250 kg, shall be placed on a target and subjected to a probe having a mass of 250 kg falling from a height of 3 m above the intended impact point. For

TEST PROCEDURES

this test the probe shall be a 20 cm diameter cylindrical bar with the striking end forming a frustum of a right circular cone with the following dimensions: 30 cm height and 2.5 cm diameter at the top with its edge rounded off to a radius of not more than 6 mm. The target on which the specimen is placed shall be as specified in para. 717.

- (b) For *packages* having a mass of 250 kg or more, the base of the probe shall be placed on a target and the specimen dropped onto the probe. The height of the drop, measured from the point of impact with the specimen to the upper surface of the probe, shall be 3 m. For this test the probe shall have the same properties and dimensions as specified in (a) above, except that the length and mass of the probe shall be such as to incur maximum damage to the specimen. The target on which the base of the probe is placed shall be as specified in para. 717.

736. Enhanced thermal test: The conditions for this test shall be as specified in para. 728, except that the exposure to the thermal environment shall be for a period of 60 minutes.

737. Impact test: The specimen shall be subject to an impact on a target at a velocity of not less than 90 m/s, at such an orientation as to suffer maximum damage. The target shall be as defined in para. 717, except that the target surface may be at any orientation as long as the surface is normal to the specimen path.

Section VIII

APPROVAL AND ADMINISTRATIVE REQUIREMENTS

GENERAL

801. For *package designs* where it is not required that a *competent authority* issue an approval certificate the *consignor* shall, on request, make available for inspection by the relevant *competent authority*, documentary evidence of the compliance of the *package design* with all the applicable requirements.

802. *Competent authority* approval shall be required for the following:

- (a) *designs* for
 - (i) *special form radioactive material* (see paras 803, 804 and 818);
 - (ii) *low dispersible radioactive material* (see paras 803 and 804);
 - (iii) *packages* containing 0.1 kg or more of uranium hexafluoride (see para. 805);
 - (iv) all *packages* containing *fissile material* unless excepted by para. 672 (see paras 812–814, 816 and 817);
 - (v) *Type B(U) packages* and *Type B(M) packages* (see paras 806–811, 816 and 817);
 - (vi) *Type C packages* (see paras 806–808);
- (b) *special arrangements* (see paras 824–826);
- (c) certain *shipments* (see paras 820–823);
- (d) *radiation protection programme* for special use *vessels* (see para. 576(a));
and
- (e) calculation of radionuclide values that are not listed in Table 1 (see para. 402).

APPROVAL OF SPECIAL FORM RADIOACTIVE MATERIAL AND LOW DISPERSIBLE RADIOACTIVE MATERIAL

803. The *design* for *special form radioactive material* shall require *unilateral approval*. The *design* for *low dispersible radioactive material* shall require *multilateral approval*. In both cases, an application for approval shall include:

SECTION VIII

- (a) a detailed description of the *radioactive material* or, if a capsule, the contents; particular reference shall be made to both physical and chemical states;
- (b) a detailed statement of the *design* of any capsule to be used;
- (c) a statement of the tests which have been done and their results, or evidence based on calculative methods to show that the *radioactive material* is capable of meeting the performance standards, or other evidence that the *special form radioactive material* or *low dispersible radioactive material* meets the applicable requirements of these Regulations;
- (d) a specification of the applicable *quality assurance* programme as required in para. 306; and
- (e) any proposed pre-shipment actions for use in the *consignment* of *special form radioactive material* or *low dispersible radioactive material*.

804. The *competent authority* shall establish an approval certificate stating that the approved *design* meets the requirements for *special form radioactive material* or *low dispersible radioactive material* and shall attribute to that *design* an identification mark.

APPROVAL OF PACKAGE DESIGNS

Approval of package designs to contain uranium hexafluoride

805. The approval of *designs* for *packages* containing 0.1 kg or more of uranium hexafluoride requires that:

- (a) Each *design* that meets the requirements of para. 632 shall require *multilateral approval*.
- (b) Each *design* that meets the requirements of paras 629–631 shall require *unilateral approval* by the *competent authority* of the country of origin of the *design*, unless *multilateral approval* is otherwise required by these regulations.
- (c) The application for approval shall include all information necessary to satisfy the *competent authority* that the *design* meets the requirements of para. 629, and a specification of the applicable *quality assurance* programme as required in para. 306;
- (d) The *competent authority* shall establish an approval certificate stating that the approved *design* meets the requirements of para. 629 and shall attribute to that *design* an identification mark.

APPROVAL AND ADMINISTRATIVE REQUIREMENTS

Approval of Type B(U) and Type C package designs

806. Each *Type B(U)* and *Type C package design* shall require *unilateral approval*, except that:

- (a) a *package design* for *fissile material*, which is also subject to paras 812–814, shall require *multilateral approval*; and
- (b) a *Type B(U) package design* for *low dispersible radioactive material* shall require *multilateral approval*.

807. An application for approval shall include:

- (a) a detailed description of the proposed *radioactive contents* with reference to their physical and chemical states and the nature of the radiation emitted;
- (b) a detailed statement of the *design*, including complete engineering drawings and schedules of materials and methods of manufacture;
- (c) a statement of the tests which have been done and their results, or evidence based on calculative methods or other evidence that the *design* is adequate to meet the applicable requirements;
- (d) the proposed operating and maintenance instructions for the use of the *packaging*;
- (e) if the *package* is designed to have a *maximum normal operating pressure* in excess of 100 kPa gauge, a specification of the materials of manufacture of the *containment system*, the samples to be taken, and the tests to be made;
- (f) where the proposed *radioactive contents* are irradiated fuel, the applicant shall state and justify any assumption in the safety analysis relating to the characteristics of the fuel and describe any pre-shipment measurement required by para. 674(b);
- (g) any special stowage provisions necessary to ensure the safe dissipation of heat from the *package* considering the various modes of transport to be used and type of *conveyance* or *freight container*;
- (h) a reproducible illustration, not larger than 21 cm by 30 cm, showing the make-up of the *package*; and
- (i) a specification of the applicable *quality assurance* programme as required in para. 306.

808. The *competent authority* shall establish an approval certificate stating that the approved *design* meets the requirements for *Type B(U)* or *Type C packages* and shall attribute to that *design* an identification mark.

SECTION VIII

Approval of Type B(M) package designs

809. Each *Type B(M) package design*, including those for *fissile material* which are also subject to paras 812–814 and those for *low dispersible radioactive material*, shall require *multilateral approval*.

810. An application for approval of a *Type B(M) package design* shall include, in addition to the information required in para. 807 for *Type B(U) packages*:

- (a) a list of the requirements specified in paras 637, 653–655 and 658–664 with which the *package* does not conform;
- (b) any proposed supplementary operational controls to be applied during transport not regularly provided for in these Regulations, but which are necessary to ensure the safety of the *package* or to compensate for the deficiencies listed in (a) above;
- (c) a statement relative to any restrictions on the mode of transport and to any special loading, carriage, unloading or handling procedures; and
- (d) the range of ambient conditions (temperature, solar radiation) which are expected to be encountered during transport and which have been taken into account in the *design*.

811. The *competent authority* shall establish an approval certificate stating that the approved *design* meets the applicable requirements for *Type B(M) packages* and shall attribute to that design an identification mark.

Approval of package designs to contain fissile material

812. Each *package design* for *fissile material* which is not excepted according to para. 672 from the requirements that apply specifically to *packages* containing *fissile material* shall require *multilateral approval*.

813. An application for approval shall include all information necessary to satisfy the *competent authority* that the *design* meets the requirements of para. 671, and a specification of the applicable *quality assurance* programme as required in para. 306.

814. The *competent authority* shall establish an approval certificate stating that the approved *design* meets the requirements of para. 671 and shall attribute to that design an identification mark.

APPROVAL AND ADMINISTRATIVE REQUIREMENTS

TRANSITIONAL ARRANGEMENTS

Packages not requiring competent authority approval of design under the 1985 and 1985 (As Amended 1990) Editions of these Regulations

815. *Excepted packages, Type IP-1, Type IP-2, Type IP-3 and Type A packages* that did not require *approval of design* by the *competent authority* and which meet the requirements of the 1985 or 1985 (As Amended 1990) Editions of these Regulations may continue to be used subject to the mandatory programme of *quality assurance* in accordance with the requirements of para. 306 and the activity limits and material restrictions of Section IV. Any *packaging* modified, unless to improve safety, or manufactured after 31 December 2003, shall meet this Edition of the Regulations in full. *Packages* prepared for transport not later than 31 December 2003 under the 1985 or 1985 (As Amended 1990) Editions of these Regulations may continue in transport. *Packages* prepared for transport after this date shall meet this Edition of the Regulations in full.

Packages approved under the 1973, 1973 (As Amended), 1985 and 1985 (As Amended 1990) Editions of these Regulations

816. *Packagings* manufactured to a *package design* approved by the *competent authority* under the provisions of the 1973 or 1973 (As Amended) Editions of these Regulations may continue to be used, subject to: *multilateral approval of package design*, the mandatory programme of *quality assurance* in accordance with the applicable requirements of para. 306; the activity limits and material restrictions of Section IV; and, for a *package* containing *fissile material* and transported by air, the requirement of para. 680. No new manufacture of such *packaging* shall be permitted to commence. Changes in the *design* of the *packaging* or in the nature or quantity of the authorized *radioactive contents* which, as determined by the *competent authority*, would significantly affect safety shall require that this Edition of the Regulations be met in full. A serial number according to the provision of para. 539 shall be assigned to and marked on the outside of each *packaging*.

817. *Packagings* manufactured to a *package design* approved by the *competent authority* under the provisions of the 1985 or 1985 (As Amended 1990) Editions of these Regulations may continue to be used, subject to: *multilateral approval of package design*, the mandatory programme of *quality assurance* in accordance with the requirements of para. 306; the activity limits and material restrictions of Section IV; and, for a *package* containing *fissile material* and

SECTION VIII

transported by air, the requirement of para. 680. Changes in the *design* of the *packaging* or in the nature or quantity of the authorized *radioactive contents* which, as determined by the *competent authority*, would significantly affect safety shall require that this Edition of the Regulations be met in full. All *packagings* for which manufacture begins after 31 December 2006 shall meet this Edition of the Regulations in full.

Special form radioactive material approved under the 1973, 1973 (As Amended), 1985 and 1985 (As Amended 1990) Editions of these Regulations

818. *Special form radioactive material* manufactured to a *design* which had received *unilateral approval* by the *competent authority* under the 1973, 1973 (As Amended), 1985 or 1985 (As Amended 1990) Editions of these Regulations may continue to be used when in compliance with the mandatory programme of *quality assurance* in accordance with the applicable requirements of para. 306. All *special form radioactive material* manufactured after 31 December 2003 shall meet this Edition of the Regulations in full.

NOTIFICATION AND REGISTRATION OF SERIAL NUMBERS

819. The *competent authority* shall be informed of the serial number of each *packaging* manufactured to a *design* approved under paras 806, 809, 812, 816 and 817.

APPROVAL OF SHIPMENTS

820. *Multilateral approval* shall be required for:

- (a) The *shipment* of *Type B(M) packages* not conforming with the requirements of para. 637 or designed to allow controlled intermittent venting;
- (b) The *shipment* of *Type B(M) packages* containing *radioactive material* with an activity greater than $3000A_1$ or $3000A_2$, as appropriate, or 1000 TBq, whichever is the lower;
- (c) The *shipment* of *packages* containing *fissile materials* if the sum of the *criticality safety indexes* of the *packages* in a single freight container or in a single conveyance exceeds 50. Excluded from this requirement shall be *shipments* by seagoing *vessels*, if the sum of the *criticality safety indexes*

APPROVAL AND ADMINISTRATIVE REQUIREMENTS

does not exceed 50 for any hold, compartment or defined deck area and the distance of 6 m between groups of *packages* or *overpacks* as required in Table 10 is met; and

- (d) *Radiation protection programmes* for *shipments* by special use *vessels* according to para. 576(a).

821. A *competent authority* may authorize transport into or through its country without *shipment* approval, by a specific provision in its *design* approval (see para. 827).

822. An application for *shipment* approval shall include:

- (a) the period of time, related to the *shipment*, for which the approval is sought;
- (b) the actual *radioactive contents*, the expected modes of transport, the type of *conveyance* and the probable or proposed route; and
- (c) the details of how the precautions and administrative or operational controls, referred to in the *package design* approval certificates issued under paras 808, 811 and 814, are to be put into effect.

823. Upon approval of the *shipment*, the *competent authority* shall issue an approval certificate.

APPROVAL OF SHIPMENTS UNDER SPECIAL ARRANGEMENT

824. Each *consignment* transported under *special arrangement* shall require *multilateral approval*.

825. An application for approval of *shipments* under *special arrangement* shall include all the information necessary to satisfy the *competent authority* that the overall level of safety in transport is at least equivalent to that which would be provided if all the applicable requirements of these Regulations had been met. The application shall also include:

- (a) A statement of the respects in which, and of the reasons why, the *shipment* cannot be made in full accordance with the applicable requirements; and
- (b) A statement of any special precautions or special administrative or operational controls which are to be employed during transport to compensate for the failure to meet the applicable requirements.

SECTION VIII

826. Upon approval of *shipments* under *special arrangement*, the *competent authority* shall issue an approval certificate.

COMPETENT AUTHORITY APPROVAL CERTIFICATES

827. Five types of approval certificates may be issued: for *special form radioactive material*, *low dispersible radioactive material*, *special arrangement*, *shipment* and *package design*. The *package design* and *shipment* approval certificates may be combined into a single certificate.

Competent authority identification marks

828. Each approval certificate issued by a *competent authority* shall be assigned an identification mark. The mark shall be of the following generalized type:

VRI/Number/Type Code

- (a) Except as provided in para. 829(b), VRI represents the international *vehicle* registration identification code of the country issuing the certificate.
- (b) The number shall be assigned by the *competent authority*, and shall be unique and specific with regard to the particular *design* or *shipment*. The *shipment* approval identification mark shall be clearly related to the *design* approval identification mark.
- (c) The following type codes shall be used in the order listed to indicate the types of approval certificates issued:

AF	<i>Type A package design for fissile material</i>
B(U)	<i>Type B(U) package design [B(U)F if for fissile material]</i>
B(M)	<i>Type B(M) package design [B(M)F if for fissile material]</i>
C	<i>Type C package design [CF if for fissile material]</i>
IF	<i>Industrial package design for fissile material</i>
S	<i>Special form radioactive material</i>
LD	<i>Low dispersible radioactive material</i>
T	<i>Shipment</i>
X	<i>Special arrangement.</i>

APPROVAL AND ADMINISTRATIVE REQUIREMENTS

In the case of *package designs* for non-fissile or fissile excepted uranium hexafluoride, where none of the above codes apply, the following type codes shall be used;

H(U) *Unilateral approval*
H(M) *Multilateral approval.*

- (d) For *package design* and *special form radioactive material* approval certificates, other than those issued under the provisions of paras 816–818, and for *low dispersible radioactive material* approval certificates, the symbols “-96” shall be added to the type code.

829. These type codes shall be applied as follows:

- (a) Each certificate and each *package* shall bear the appropriate identification mark, comprising the symbols prescribed in paras 828(a), (b), (c) and (d) above, except that, for *packages*, only the applicable *design* type codes including, if applicable, the symbols ‘-96’ shall appear following the second stroke, that is, the ‘T’ or ‘X’ shall not appear in the identification marking on the *package*. Where the *design* approval and *shipment* approval are combined, the applicable type codes do not need to be repeated. For example:

A/132/B(M)F-96: A *Type B(M) package design* approved for *fissile material*, requiring *multilateral approval*, for which the *competent authority* of Austria has assigned the *design* number 132 (to be marked both on the *package* and on the *package design* approval certificate);

A/132/B(M)F-96T: The *shipment* approval issued for a *package* bearing the identification mark elaborated above (to be marked on the certificate only);

A/137/X: A *special arrangement* approval issued by the *competent authority* of Austria, to which the number 137 has been assigned (to be marked on the certificate only);

A/139/IF-96: An *Industrial package design* for *fissile material* approved by the *competent authority* of Austria, to which *package design* number 139 has been assigned (to be marked both on the *package* and on the *package design* approval certificate); and

SECTION VIII

A/145/H(U)-96: A *package design* for fissile excepted uranium hexafluoride approved by the *competent authority* of Austria, to which *package design* number 145 has been assigned (to be marked both on the *package* and on the *package design* approval certificate).

- (b) Where *multilateral approval* is effected by validation according to para. 834, only the identification mark issued by the country of origin of the *design* or *shipment* shall be used. Where *multilateral approval* is effected by issue of certificates by successive countries, each certificate shall bear the appropriate identification mark, and the *package* whose *design* was so approved shall bear all appropriate identification marks. For example:

A/132/B(M)F-96
CH/28/B(M)F-96

would be the identification mark of a *package* which was originally approved by Austria and was subsequently approved, by separate certificate, by Switzerland. Additional identification marks would be tabulated in a similar manner on the *package*.

- (c) The revision of a certificate shall be indicated by a parenthetical expression following the identification mark on the certificate. For example, A/132/B(M)F-96(Rev.2) would indicate revision 2 of the Austrian *package design* approval certificate; or A/132/B(M)F-96(Rev.0) would indicate the original issuance of the Austrian *package design* approval certificate. For original issuances, the parenthetical entry is optional and other words such as 'original issuance' may also be used in place of 'Rev.0'. Certificate revision numbers may only be issued by the country issuing the original approval certificate.
- (d) Additional symbols (as may be necessitated by national requirements) may be added in brackets to the end of the identification mark; for example, A/132/B(M)F-96(SP503).
- (e) It is not necessary to alter the identification mark on the *packaging* each time that a revision to the *design* certificate is made. Such re-marking shall be required only in those cases where the revision to the *package design* certificate involves a change in the letter type codes for the *package design* following the second stroke.

APPROVAL AND ADMINISTRATIVE REQUIREMENTS

CONTENTS OF APPROVAL CERTIFICATES

Special form radioactive material and low dispersible radioactive material approval certificates

830. Each approval certificate issued by a *competent authority* for *special form radioactive material* or *low dispersible radioactive material* shall include the following information:

- (a) Type of certificate.
- (b) The *competent authority* identification mark.
- (c) The issue date and an expiry date.
- (d) List of applicable national and international regulations, including the edition of the IAEA Regulations for the Safe Transport of Radioactive Material under which the *special form radioactive material* or *low dispersible radioactive material* is approved.
- (e) The identification of the *special form radioactive material* or *low dispersible radioactive material*.
- (f) A description of the *special form radioactive material* or *low dispersible radioactive material*.
- (g) *Design* specifications for the *special form radioactive material* or *low dispersible radioactive material*, which may include references to drawings.
- (h) A specification of the *radioactive contents* which includes the activities involved and which may include the physical and chemical forms.
- (i) A specification of the applicable *quality assurance* programme as required in para. 306.
- (j) Reference to information provided by the applicant relating to specific actions to be taken prior to *shipment*.
- (k) If deemed appropriate by the *competent authority*, reference to the identity of the applicant.
- (l) Signature and identification of the certifying official.

Special arrangement approval certificates

831. Each approval certificate issued by a *competent authority* for a *special arrangement* shall include the following information:

- (a) Type of certificate.
- (b) The *competent authority* identification mark.
- (c) The issue date and an expiry date.
- (d) Mode(s) of transport.

SECTION VIII

- (e) Any restrictions on the modes of transport, type of *conveyance*, *freight container*, and any necessary routing instructions.
- (f) List of applicable national and international regulations, including the edition of the IAEA Regulations for the Safe Transport of Radioactive Material under which the *special arrangement* is approved.
- (g) The following statement:

“This certificate does not relieve the consignor from compliance with any requirement of the government of any country through or into which the package will be transported.”
- (h) References to certificates for alternative *radioactive contents*, other *competent authority* validation, or additional technical data or information, as deemed appropriate by the *competent authority*.
- (i) Description of the *packaging* by a reference to the drawings or a specification of the *design*. If deemed appropriate by the *competent authority*, a reproducible illustration not larger than 21 cm by 30 cm, showing the make-up of the *package*, should also be provided, accompanied by a brief description of the *packaging*, including materials of manufacture, gross mass, general outside dimensions and appearance.
- (j) A specification of the authorized *radioactive contents*, including any restrictions on the *radioactive contents* which might not be obvious from the nature of the *packaging*. This shall include the physical and chemical forms, the activities involved (including those of the various isotopes, if appropriate), amounts in grams (for *fissile material*), and whether *special form radioactive material* or *low dispersible radioactive material*, if applicable.
- (k) Additionally, for *packages* containing *fissile material*:
 - (i) a detailed description of the authorized *radioactive contents*;
 - (ii) the value of the *criticality safety index*;
 - (iii) reference to the documentation that demonstrates the criticality safety of the contents;
 - (iv) any special features on the basis of which the absence of water from certain void spaces has been assumed in the criticality assessment;
 - (v) any allowance (based on para. 674(b)) for a change in neutron multiplication assumed in the criticality assessment as a result of actual irradiation experience; and
 - (vi) the ambient temperature range for which the *special arrangement* has been approved.
- (l) A detailed listing of any supplementary operational controls required for preparation, loading, carriage, unloading and handling of the *consignment*, including any special stowage provisions for the safe dissipation of heat.

APPROVAL AND ADMINISTRATIVE REQUIREMENTS

- (m) If deemed appropriate by the *competent authority*, reasons for the *special arrangement*.
- (n) Description of the compensatory measures to be applied as a result of the *shipment* being under *special arrangement*.
- (o) Reference to information provided by the applicant relating to the use of the *packaging* or specific actions to be taken prior to the *shipment*.
- (p) A statement regarding the ambient conditions assumed for purposes of *design* if these are not in accordance with those specified in paras 654, 655 and 664, as applicable.
- (q) Any emergency arrangements deemed necessary by the *competent authority*.
- (r) A specification of the applicable *quality assurance* programme as required in para. 306.
- (s) If deemed appropriate by the *competent authority*, reference to the identity of the applicant and to the identity of the *carrier*.
- (t) Signature and identification of the certifying official.

Shipment approval certificates

832. Each approval certificate for a *shipment* issued by a *competent authority* shall include the following information:

- (a) Type of certificate.
- (b) The *competent authority* identification mark(s).
- (c) The issue date and an expiry date.
- (d) List of applicable national and international regulations, including the edition of the IAEA Regulations for the Safe Transport of Radioactive Material under which the *shipment* is approved.
- (e) Any restrictions on the modes of transport, type of *conveyance*, *freight container*, and any necessary routing instructions.
- (f) The following statement:
“This certificate does not relieve the consignor from compliance with any requirement of the government of any country through or into which the package will be transported.”
- (g) A detailed listing of any supplementary operational controls required for preparation, loading, carriage, unloading and handling of the *consignment*, including any special stowage provisions for the safe dissipation of heat or maintenance of criticality safety.
- (h) Reference to information provided by the applicant relating to specific actions to be taken prior to *shipment*.
- (i) Reference to the applicable *design* approval certificate(s).

SECTION VIII

- (j) A specification of the actual *radioactive contents*, including any restrictions on the *radioactive contents* which might not be obvious from the nature of the *packaging*. This shall include the physical and chemical forms, the total activities involved (including those of the various isotopes, if appropriate), amounts in grams (for *fissile material*), and whether *special form radioactive material* or *low dispersible radioactive material*, if applicable.
- (k) Any emergency arrangements deemed necessary by the *competent authority*.
- (l) A specification of the applicable *quality assurance* programme as required in para. 306.
- (m) If deemed appropriate by the *competent authority*, reference to the identity of the applicant.
- (n) Signature and identification of the certifying official.

Package design approval certificates

833. Each approval certificate of the *design* of a *package* issued by a *competent authority* shall include the following information:

- (a) Type of certificate.
- (b) The *competent authority* identification mark.
- (c) The issue date and an expiry date.
- (d) Any restriction on the modes of transport, if appropriate.
- (e) List of applicable national and international regulations, including the edition of the IAEA Regulations for the Safe Transport of Radioactive Material under which the *design* is approved.
- (f) The following statement:
“This certificate does not relieve the consignor from compliance with any requirement of the government of any country through or into which the package will be transported.”
- (g) References to certificates for alternative *radioactive contents*, other *competent authority* validation, or additional technical data or information, as deemed appropriate by the *competent authority*.
- (h) A statement authorizing *shipment* where *shipment* approval is required under para. 820, if deemed appropriate.
- (i) Identification of the *packaging*.
- (j) Description of the *packaging* by a reference to the drawings or specification of the *design*. If deemed appropriate by the *competent authority*, a reproducible illustration not larger than 21 cm by 30 cm, showing the make-up of the *package*, should also be provided,

APPROVAL AND ADMINISTRATIVE REQUIREMENTS

accompanied by a brief description of the *packaging*, including materials of manufacture, gross mass, general outside dimensions and appearance.

- (k) Specification of the *design* by reference to the drawings.
- (l) A specification of the authorized *radioactive contents*, including any restrictions on the *radioactive contents* which might not be obvious from the nature of the *packaging*. This shall include the physical and chemical forms, the activities involved (including those of the various isotopes, if appropriate), amounts in grams (for *fissile material*), and whether *special form radioactive material* or *low dispersible radioactive material*, if applicable.
- (m) A description of the *containment system*.
- (n) Additionally, for *packages* containing *fissile material*:
 - (i) A detailed description of the authorized *radioactive contents*;
 - (ii) A description of the *confinement system*;
 - (iii) The value of the *criticality safety index*;
 - (iv) Reference to the documentation that demonstrates the criticality safety of the contents;
 - (v) Any special features on the basis of which the absence of water from certain void spaces has been assumed in the criticality assessment;
 - (vi) Any allowance (based on para. 674(b)) for a change in neutron multiplication assumed in the criticality assessment as a result of actual irradiation experience; and
 - (vii) The ambient temperature range for which the *package design* has been approved.
- (o) For *Type B(M) packages*, a statement specifying those prescriptions of paras 637, 653–655 and 658–664 with which the *package* does not conform and any amplifying information which may be useful to other *competent authorities*.
- (p) For *packages* containing more than 0.1 kg of uranium hexafluoride, a statement specifying those prescriptions of para. 632 that apply, if any, and any amplifying information which may be useful to other *competent authorities*.
- (q) A detailed listing of any supplementary operational controls required for preparation, loading, carriage, unloading and handling of the *consignment*, including any special stowage provisions for the safe dissipation of heat.
- (r) Reference to information provided by the applicant relating to the use of the *packaging* or specific actions to be taken prior to *shipment*.

SECTION VIII

- (s) A statement regarding the ambient conditions assumed for purposes of *design* if these are not in accordance with those specified in paras 654, 655 and 664, as applicable.
- (t) A specification of the applicable *quality assurance* programme as required in para. 306.
- (u) Any emergency arrangements deemed necessary by the *competent authority*.
- (v) If deemed appropriate by the *competent authority*, reference to the identity of the applicant.
- (w) Signature and identification of the certifying official.

VALIDATION OF CERTIFICATES

834. *Multilateral approval* may be by validation of the original certificate issued by the *competent authority* of the country of origin of the *design* or *shipment*. Such validation may take the form of an endorsement on the original certificate or the issuance of a separate endorsement, annex, supplement, etc., by the *competent authority* of the country through or into which the *shipment* is made.

REFERENCES

The editions of the publications cited as references in these Regulations are current at the time of publication. The most recent editions should be consulted in defining requirements established in these Regulations.

- [1] INTERNATIONAL ATOMIC ENERGY AGENCY, Radiation Protection and the Safety of Radiation Sources, Safety Series No. 120, IAEA, Vienna (1996).
- [2] FOOD AND AGRICULTURE ORGANIZATION OF THE UNITED NATIONS, INTERNATIONAL ATOMIC ENERGY AGENCY, INTERNATIONAL LABOUR ORGANISATION, OECD NUCLEAR ENERGY AGENCY, PAN AMERICAN HEALTH ORGANIZATION, WORLD HEALTH ORGANIZATION, International Basic Safety Standards for Protection against Ionizing Radiation and for the Safety of Radiation Sources, Safety Series No. 115, IAEA, Vienna (1996).
- [3] INTERNATIONAL ATOMIC ENERGY AGENCY, Advisory Material for the IAEA Regulations for the Safe Transport of Radioactive Material, IAEA Safety Standards Series No. TS-G-1.1 (ST-2), IAEA, Vienna (2002).
- [4] INTERNATIONAL ATOMIC ENERGY AGENCY, Planning and Preparing for Emergency Response to Transport Accidents Involving Radioactive Material, IAEA Safety Standards Series No. TS-G-1.2 (ST-3), IAEA, Vienna (2002).
- [5] INTERNATIONAL ATOMIC ENERGY AGENCY, Compliance Assurance for the Safe Transport of Radioactive Material, IAEA Safety Standards Series No. TS-G-1.4, IAEA, Vienna (in preparation).
- [6] INTERNATIONAL ATOMIC ENERGY AGENCY, Quality Assurance for the Safe Transport of Radioactive Material, IAEA Safety Standards Series No. TS-G-1.3, IAEA, Vienna (in preparation).
- [7] UNITED NATIONS, Recommendations on the Transport of Dangerous Goods, Ninth Revised Edition (ST/SG/AC.10/1/Rev.9), UN, New York and Geneva (1995).
- [8] INTERNATIONAL ORGANIZATION FOR STANDARDIZATION, Radiation Protection — Sealed Radioactive Sources — Leakage Test Methods, ISO 9978:1992(E), ISO, Geneva (1992).
- [9] INTERNATIONAL ORGANIZATION FOR STANDARDIZATION, Series 1 Freight Containers — Specifications and Testing — Part 1: General Cargo Containers, ISO 1496:1-1990(E), ISO, Geneva (1990).
- [10] INTERNATIONAL ORGANIZATION FOR STANDARDIZATION, Packaging of Uranium Hexafluoride (UF₆) for Transport, ISO 7195:1993(E), ISO, Geneva (1993).
- [11] INTERNATIONAL ORGANIZATION FOR STANDARDIZATION, Sealed Radioactive Sources — Classification, ISO 2919:1980(E), ISO, Geneva (1980).

Annex I

SUMMARY OF APPROVAL AND PRIOR NOTIFICATION REQUIREMENTS

This summary reflects the contents of the Regulations for the Safe Transport of Radioactive Material (1996 Edition). The user's attention is called to the fact that there may be deviations (exceptions, additions, etc.) relative to:

- (a) national regulations relating to safety,
- (b) *carrier* restrictions, and
- (c) national regulations relating to security, physical protection, liability, insurance, pre-notification and/or routing, and import/export/transit licensing.

ANNEX I

Key paragraphs in the Regulations	Class of package or material	Competent authority approval required		Consignor required to notify country of origin and countries en route ^a of each shipment
		Country of origin	Countries en route ^a	
	<i>Excepted package^b by domestic post</i>	No	Not applicable	No
	<i>Excepted package^b by international post</i>	Yes, of consignor	No	No
	– <i>Package design</i>	No	No	No
	– <i>Shipment</i>	No	No	No
581	– <i>Consignor</i>	Yes	Not applicable	No
	<i>Excepted package^b other than by post</i>	No	No	No
	<i>LSA material^{b,c} and SCO^c</i>	No	No	No
	– <i>Type IP-1, Type IP-2 or Type IP-3</i>			
	<i>Type A^{b,c}</i>	No	No	No

^a Countries through or into which (but not over which) the *consignment* is transported (see para. 204 of the Regulations).

^b If the *radioactive contents* are UF₆ in quantities of 0.1 kg or more, the approval requirements for *packages* containing uranium hexafluoride shall additionally apply (see paras 802 and 805 of the Regulations).

^c If the *radioactive contents* are *fissile material* which is not excepted from the requirements for *packages* containing *fissile material*, then the approval requirements in paras 812 and 820 of the Regulations shall additionally apply.

SUMMARY OF APPROVAL AND PRIOR NOTIFICATION REQUIREMENTS

Key paragraphs in the Regulations	Class of package or material	Competent authority approval required		Consignor required to notify country of origin and countries en route ^a of each shipment
		Country of origin	Countries en route ^a	
<i>Type B(U)^{b,c}</i>				
806, 820	– <i>Package design</i>	Yes	No ^d	
558, 559	– <i>Shipment</i>	No	No	(See Notes 1 + 2)
<i>Type B(M)^{b,c}</i>				
809, 820	– <i>Package design</i>	Yes	Yes	Yes
558, 559	– <i>Shipment</i>	(See Note 3)	(See Note 3)	(See Note 1)
<i>Type C^{b,c}</i>				
806, 820	– <i>Package design</i>	Yes	No	
558, 559	– <i>Shipment</i>	No	No	(See Notes 1 + 2)

^a Countries through or into which (but not over which) the *consignment* is transported (see para. 204 of the Regulations).

^b If the *radioactive contents* are *fissile material* which is not excepted from the requirements for *packages* containing *fissile material*, then the approval requirements in paras 812 and 820 of the Regulations shall additionally apply.

^c If the *radioactive contents* are UF₆ in quantities of 0.1 kg or more, the approval requirements for *packages* containing uranium hexafluoride shall additionally apply (see paras 802 and 805 of the Regulations).

^d If the *radioactive contents* are *low dispersible radioactive material*, and the *package* is to be shipped by air, *multilateral approval* of the *package design* is required (see para. 806(b) of the Regulations).

Note 1: Before the first *shipment* of any *package* requiring *competent authority* approval of the *design*, the *consignor* shall ensure that a copy of the approval certificate for that *design* has been submitted to the *competent authority* of each country (see para. 558 of the Regulations).

Note 2: Notification required if contents exceed $3 \times 10^3 A_1$, or $3 \times 10^3 A_2$, or 1000 TBq, whichever is the lower (see para. 559 of the Regulations).

Note 3: *Multilateral approval* of *shipment* required if contents exceed $3 \times 10^3 A_1$, or $3 \times 10^3 A_2$, or 1000 TBq, whichever is the lower, or if controlled intermittent venting is allowed (see para. 820 of the Regulations).

ANNEX I

Key paragraphs in the Regulations	Class of package or material	Competent authority approval required		Consignor required to notify country of origin and countries en route ^a of each shipment
		Country of origin	Countries en route ^a	
<i>Packages for fissile material</i>				
812	— <i>Package design</i>	Yes ^b	Yes ^b	
820	— <i>Shipment</i>			
	Σ <i>CSI</i> ≤ 50	No ^c	No ^c	(See Notes 1 + 2)
	Σ <i>CSI</i> > 50	Yes	Yes	(See Notes 1 + 2)
<i>Packages containing 0.1 kg or more of uranium hexafluoride</i>				
805	— <i>Package design</i>	No ^d	No ^d	
820	— <i>Shipment</i>	No ^c	No ^c	(See Note 2)

^a Countries through or into which (but not over which) the *consignment* is transported (see para. 204 of the Regulations).

^b *Designs* of packages containing *fissile material* may also require approval in respect of one of the other items in Annex I.

^c *Shipments* may, however, require approval in respect of one of the other items in Annex I.

^d Except that, after 31 December 2000, designs that only meet the requirement of para. 632 require *multilateral approval*, and after 31 December 2003, designs that meet the requirements of paras 629–631 require *unilateral approval* by the *competent authority* of the country of origin of the *design* (para. 805).

Note 1: The *multilateral approval* requirement for *fissile packages* and some uranium hexafluoride *packages* automatically satisfies the requirement of para. 558 of the Regulations.

Note 2: Notification required if contents exceed $3 \times 10^3 A_1$, or $3 \times 10^3 A_2$, or 1000 TBq, whichever is the lower (see para. 559 of the Regulations).

SUMMARY OF APPROVAL AND PRIOR NOTIFICATION REQUIREMENTS

Key paragraphs in the Regulations	Class of package or material	Competent authority approval required		Consignor required to notify country of origin and countries en route ^a of each shipment
		Country of origin	Countries en route ^a	
	<i>Special form radioactive material</i>			
803	– Design	Yes	No	No
820	– Shipment	(See Note 1)	(See Note 1)	(See Note 1)
	<i>Low dispersible radioactive material</i>			
803	– Design	Yes	Yes	No
820	– Shipment	(See Note 1)	(See Note 1)	(See Note 1)
	<i>Special arrangement</i>			
802 824, 559	– Shipment	Yes	Yes	Yes
	Type B(U) packages for which design is approved under:			
816	1973 Regulations	Yes	Yes	(See Note 2)
817	1985 Regulations	Yes	No until 31 December 2003 Yes thereafter	(See Note 2)

^a Countries through or into which (but not over which) the *consignment* is transported (see para. 204 of the Regulations).

Note 1: See approval and prior notification requirements for applicable *package*.

Note 2: Before the first *shipment* of any *package* requiring *competent authority* approval of the *design*, the *consignor* shall ensure that a copy of the approval certificate for that *design* has been submitted to the *competent authority* of each country (see para. 558 of the Regulations).

Annex II

CONVERSION FACTORS AND PREFIXES

This edition of the Regulations for the Safe Transport of Radioactive Material uses the International System of Units (SI). The conversion factors for non-SI units are:

RADIATION UNITS

Activity in becquerel (Bq) or curie (Ci)

$$1 \text{ Ci} = 3.7 \times 10^{10} \text{ Bq}$$

$$1 \text{ Bq} = 2.7 \times 10^{-11} \text{ Ci}$$

Dose equivalent in sievert (Sv) or rem

$$1 \text{ rem} = 1.0 \times 10^{-2} \text{ Sv}$$

$$1 \text{ Sv} = 100 \text{ rem}$$

PRESSURE

Pressure in pascal (Pa) or (kgf/cm²)

$$1 \text{ kgf/cm}^2 = 9.806 \times 10^4 \text{ Pa}$$

$$1 \text{ Pa} = 1.020 \times 10^{-5} \text{ kgf/cm}^2$$

CONDUCTIVITY

Conductivity in siemens per metre (S/m) or (mho/cm)

$$10 \text{ } \mu\text{mho/cm} = 1 \text{ mS/m}$$

or

$$1 \text{ mho/cm} = 100 \text{ S/m}$$

$$1 \text{ S/m} = 10^{-2} \text{ mho/cm}$$

CONVERSION FACTORS AND PREFIXES

SI PREFIXES AND SYMBOLS

The decimal multiples and submultiples of a unit may be formed by prefixes or symbols, having the following meanings, placed before the name or symbol of the unit:

Multiplying factor	Prefix	Symbol
1 000 000 000 000 000 000 = 10^{18}	exa	E
1 000 000 000 000 000 = 10^{15}	peta	P
1 000 000 000 000 = 10^{12}	tera	T
1 000 000 000 = 10^9	giga	G
1 000 000 = 10^6	mega	M
1 000 = 10^3	kilo	k
100 = 10^2	hecto	h
10 = 10^1	deca	da
0.1 = 10^{-1}	deci	d
0.01 = 10^{-2}	centi	c
0.001 = 10^{-3}	milli	m
0.000 001 = 10^{-6}	micro	μ
0.000 000 001 = 10^{-9}	nano	n
0.000 000 000 001 = 10^{-12}	pico	p
0.000 000 000 000 001 = 10^{-15}	femto	f
0.000 000 000 000 000 001 = 10^{-18}	atto	a

CONTRIBUTORS TO DRAFTING AND REVIEW

Abonyi, T.	Institute of Isotope and Surface Chemistry, Hungary
Abouchaar, J.	Air Transport Association, Canada
Aceña, V.	Consejo de Seguridad Nuclear, Spain
Agapov, A.	Ministry of the Russian Federation on Atomic Energy, Russian Federation
Agarwal, S.P.	Atomic Energy Regulatory Board, India
Aguilar, J.	DGSNR, France
Akiyama, H.	Nuclear Fuel Transport Co., Japan
Ando, H.	Japan Nuclear Cycle Development Institute, Japan
Asano, R.	Hitachi Zosen, Japan
Baekelandt, L.	Federal Agency for Nuclear Control, Belgium
Bakalova, A.	Nuclear Regulatory Agency, Bulgaria
Bayley, B.	World Nuclear Transport Institute, United Kingdom
Bekker, B.	Nuclear Technology Products, South Africa
Bell, K.-H.	Federal Ministry of Transport, Building and Housing, Germany
Berchik, V.	Ministry of the Russian Federation on Atomic Energy, Russian Federation
Bernard-Bruls, X.	International Atomic Energy Agency
Binet, J.	European Commission
Börst, F.-M.	Bundesamt für Strahlenschutz, Germany

CONTRIBUTORS TO DRAFTING AND REVIEW

Bove, R.	Ente Nazionale per le Nuove Tecnologie, l'Energia e l'Ambiente, Italy
Boyle, R.	Department of Transportation, United States of America
Brittinger, M.T.	International Atomic Energy Agency
Charette, M.	Atomic Energy Control Board, Canada
Christ, R.	World Nuclear Transport Institute, United Kingdom
Clark, R.	Transport Canada, Canada
Cook, J.	Nuclear Regulatory Commission, United States of America
Cottens, E.	Federal Agency for Nuclear Control, Belgium
Dekker, B.	World Nuclear Transport Institute, United Kingdom
Desnoyers, B.	Cogéma, France
Dicke, G.	International Atomic Energy Agency
Ducháček, V.	State Office for Nuclear Safety, Czech Republic
Dybeck, P.	Swedish Nuclear Fuel and Waste Management Co., Sweden
El-Rahman, F.A.M.	National Center of Nuclear Safety and Radiation Control, Egypt
Enriquez, C.	Empresa Nacional de Residuos Radiactivos, Spain
Ershov, V.	MINATOM, Russian Federation
Eyre, P.	Canadian Nuclear Safety Commission, Canada
Faille, S.	Canadian Nuclear Safety Commission, Canada

CONTRIBUTORS TO DRAFTING AND REVIEW

Fasten, C.	Bundesamt für Strahlenschutz, Germany
Flynn, M.	British Nuclear Fuels plc, United Kingdom
Gale, B.	Atomic Energy of Canada Ltd, Canada
Garg, R.	Canadian Nuclear Safety Commission, Canada
Gessl, M.	International Federation of Air Line Pilots' Associations
Giroux, P.	Universal Postal Union
González, A.	International Atomic Energy Agency
Green, C.	Cameco Corporation, Canada
Hägglom, E.	Swedish Nuclear Power Inspectorate, Sweden
Hair, J.	United Kingdom Atomic Energy Authority, United Kingdom
Hall, G.	AWE, United Kingdom
Harvey, J.	United Kingdom Atomic Energy Authority, United Kingdom
Hashimoto, M.	Japan Nuclear Cycle Development Institute, Japan
Hirose, M.	Mitsui Engineering and Shipbuilding Co. Ltd, Japan
Hornkjøl, S.	Norwegian Radiation Protection Authority, Norway
Hughes, J.	National Radiological Protection Board, United Kingdom
Ito, T.	Japan Nuclear Cycle Development Institute, Japan
Itoh, C.	Central Research Institute of Electric Power Industry, Japan

CONTRIBUTORS TO DRAFTING AND REVIEW

Jacob, E.	Direction Générale de la Sûreté Nucléaire et de la Radioprotection, France
Kervella, O.	United Nations Economic Commission for Europe
Koca, I.	Permanent Mission of Turkey to the IAEA, Turkey
Krammer, O.	Bundesministerium für Wissenschaft, Verkehr und Kunst, Austria
Krembel, D.	Direction de la Sûreté des Installations Nucléaires, France
Krietsch, T.	Bundesamt für Materialforschung und -prüfung, Germany
Krzaniak, M.	MDS Nordion, Canada
Kübel, M.	World Nuclear Transport Institute
Lavarenne, C.	IRSN/DSU/SEC, France
Le Mao, S.	Institut de Protection et de Sûreté Nucléaire, France
Liebens, M.	Federal Agency for Nuclear Control, Belgium
Lizot, M.T.	Institut de Radioprotection et de Sûreté Nucléaire, France
Lo, K.	Ontario Power Generation, Canada
Lopez Vietri, J.	Autoridad Regulatoria Nuclear, Argentina
Malésys, P.	International Organization for Standardization
Mennerdahl, D.	E. Mennerdahl Systems, Sweden
Metcalf, P.	International Atomic Energy Agency
Mirfakaraei, P.	Canadian Nuclear Safety Commission, Canada
Nakayama, T.	Ministry of Transport, Japan

CONTRIBUTORS TO DRAFTING AND REVIEW

Nandakumar, A.N.	Bhabha Atomic Research Centre, India
Neubauer, J.	Forschungszentrum Seibersdorf, Austria
Neven, M.	Cameco Corp., Canada
Nickell, R.	Private consultant, United States of America
Niel, J.C.	Institut de Protection et de Sûreté Nucléaire, France
Nitsche, F.	Bundesamt für Strahlenschutz, Germany
Ntuane, B.	National Nuclear Regulator, South Africa
Ohashi, S.	Nuclear and Industrial Safety Agency, Japan
Oretani, M.	Ministry of Land, Infrastructure and Transport, Japan
Orsini, A.	Ente Nazionale per le Nuove Tecnologie, l'Energia e l'Ambiente, Italy
Osgood, N.	Nuclear Regulatory Commission, United States of America
Ouchi, Y.	Japan Nuclear Cycle Development Institute, Japan
Owen, G.	British Nuclear Fuels plc, United Kingdom
Paganelli, M.	Agenzia Nazionale per la Protezione dell'Ambiente, Italy
Parks, C.	Oak Ridge National Laboratory, United States of America
Pope, R.	International Atomic Energy Agency
Poppl, J.	European Federation for Non-destructive Testing
Pu, Y.	China National Nuclear Corp., China
Rawl, R.	International Atomic Energy Agency

CONTRIBUTORS TO DRAFTING AND REVIEW

Reiche, I.	Bundesamt für Strahlenschutz, Germany
Roberts, D.J.	AWE plc, United Kingdom
Rödel, R.	Bundesanstalt für Materialforschung und -prüfung, Germany
Rogatchev, A.	Permanent Mission of Bulgaria to the IAEA, Bulgaria
Rogers, D.	REVISS Services (UK) Ltd, United Kingdom
Rooney, K.	International Civil Aviation Organization
Rossi, L.	European Commission
Rouyer, V.	Institut de Radioprotection et de Sûreté Nucleaire, France
Sáfár, J.	Hungarian Atomic Energy Authority, Hungary
Sannen, H.	Transnubel, Belgium
Sert, G.	Institut de Protection et de Sûreté Nucléaire, France
Sievwright, B.	UK Nirex Ltd, United Kingdom
Stewart, J.	Department of Transport, United Kingdom
Sukhovorov-Zhornovy, B.	Ministry of Fuel and Energy of Ukraine, Ukraine
Svahn, B.	Swedish Radiation Protection Institute, Sweden
Takani, M.	Nuclear Fuel Transport Co., Japan
Tetényi, P.	Institute of Isotope and Surface Chemistry, Hungary
Torres, G.	Permanent Mission of Chile to the International Organizations in Vienna

CONTRIBUTORS TO DRAFTING AND REVIEW

Trivelloni, S.	Agenzia Nazionale per la Protezione dell'Ambiente, Italy
Van Aarle, J.	Swiss Federal Nuclear Safety Inspectorate, Switzerland
Van Halem, H.	Ministry of Housing, Spatial Planning and the Environment, Netherlands
Van Rij, S.	European Commission
Vieru, G.	Institute for Nuclear Research, Romania
Vogiatzi, S.	Greek Atomic Energy Commission, Greece
Wangler, M.	International Atomic Energy Agency
Warden, D.	Nycomed-Amersham plc, United Kingdom
Whittingham, S.	British Nuclear Fuels plc, United Kingdom
Yamanaka, T.	Japan Nuclear Energy Safety Organization, Japan
Yamashita, Y.	Ministry of Economy, Trade and Industry, Japan
Young, C.	Department of Transport, United Kingdom
Zamora, F.	Consejo de Seguridad Nuclear, Spain
Zhao, Y.	Permanent Mission of China to the International Organizations in Vienna

BODIES FOR THE ENDORSEMENT OF IAEA SAFETY STANDARDS

An asterisk () denotes a corresponding member. Corresponding members receive drafts for comment and other documentation but they do not generally participate in meetings.*

Commission on Safety Standards

Argentina: Oliveira, A.; Australia: Loy, J.; Brazil: Souza de Assis, A.; Canada: Pereira, J.K.; China: Li, G.; Czech Republic: Drabova, D.; Denmark: Ulbak, K.; Egypt: Abdel-Hamid, S.B.; France: Lacoste, A.-C.; Germany: Majer, D.; India: Sukhatme, S.P.; Japan: Abe, K.; Korea, Republic of: Eun, Y.-S.; Pakistan: Hashimi, J.; Russian Federation: Malyshev, A.B.; Spain: Azuara, J.A.; Sweden: Holm, L.-E.; Switzerland: Schmocker, U.; United Kingdom: Williams, L.G. (Chairperson); United States of America: Virgilio, M.; IAEA: Karbassioun, A.; European Commission: Waeterloos, C.; International Commission on Radiological Protection: Holm, L.-E.; OECD Nuclear Energy Agency: Shimomura, K.

Nuclear Safety Standards Committee

*Argentina: Sajaroff, P.; Australia: MacNab, D.; *Belarus: Sudakou, I.; Belgium: Govaerts, P.; Brazil: Salati de Almeida, I.P.; Bulgaria: Gantchev, T.; Canada: Hawley, P.; China: Wang, J.; Czech Republic: Böhm, K.; *Egypt: Hassib, G.; Finland: Reiman, L. (Chairperson); France: Saint Raymond, P.; Germany: Feige, G.; Hungary: Vöröss, L.; India: Kushwaha, H.S.; Ireland: Hone, C.; Israel: Hirshfeld, H.; Japan: Yamamoto, T.; Korea, Republic of: Lee, J.-I.; Lithuania: Demcenko, M.; *Mexico: Delgado Guardado, J.L.; Netherlands: de Munk, P.; *Pakistan: Hashimi, J.A.; *Peru: Ramírez Quijada, R.; Russian Federation: Baklushin, R.P.; South Africa: Bester, P.J.; Spain: Mellado, I.; Sweden: Jende, E.; Switzerland: Aeberli, W.; *Thailand: Tanipanichskul, P.; Turkey: Alten, S.; United Kingdom: Hall, A.; United States of America: Mayfield, M.E.; European Commission: Schwartz, J.-C.; IAEA: Bevington, L. (Coordinator); International Organization for Standardization: Nigon, J.L.; OECD Nuclear Energy Agency: Hrehor, M.*

BODIES FOR THE ENDORSEMENT OF SAFETY STANDARDS

Radiation Safety Standards Committee

Argentina: Rojkind, R.H.A.; *Australia:* Melbourne, A.; **Belarus:* Rydlevski, L.; *Belgium:* Smeesters, P.; *Brazil:* Amaral, E.; *Canada:* Bundy, K.; *China:* Yang, H.; *Cuba:* Betancourt Hernandez, A.; *Czech Republic:* Drabova, D.; *Denmark:* Ulbak, K.; **Egypt:* Hanna, M.; *Finland:* Markkanen, M.; *France:* Piechowski, J.; *Germany:* Landfermann, H.; *Hungary:* Koblinger, L.; *India:* Sharma, D.N.; *Ireland:* Colgan, T.; *Israel:* Laichter, Y.; *Italy:* Sgrilli, E.; *Japan:* Yamaguchi, J.; *Korea, Republic of:* Kim, C.W.; **Madagascar:* Andriambololona, R.; **Mexico:* Delgado Guardado, J.L.; **Netherlands:* Zuur, C.; *Norway:* Saxebol, G.; **Peru:* Medina Gironzini, E.; *Poland:* Merta, A.; *Russian Federation:* Kutkov, V.; *Slovakia:* Jurina, V.; *South Africa:* Olivier, J.H.I.; *Spain:* Amor, I.; *Sweden:* Hofvander, P.; Moberg, L.; *Switzerland:* Pfeiffer, H.J.; **Thailand:* Pongpat, P.; *Turkey:* Uslu, I.; *Ukraine:* Likhtarev, I.A.; *United Kingdom:* Robinson, I. (Chairperson); *United States of America:* Paperiello, C.; *European Commission:* Janssens, A.; *IAEA:* Boal, T. (Coordinator); *International Commission on Radiological Protection:* Valentin, J.; *International Labour Office:* Niu, S.; *International Organization for Standardization:* Perrin, M.; *International Radiation Protection Association:* Webb, G.; *OECD Nuclear Energy Agency:* Lazo, T.; *Pan American Health Organization:* Jimenez, P.; *United Nations Scientific Committee on the Effects of Atomic Radiation:* Gentner, N.; *World Health Organization:* Carr, Z.

Transport Safety Standards Committee

Argentina: López Vietri, J.; *Australia:* Colgan, P.; **Belarus:* Zaitsev, S.; *Belgium:* Cottens, E.; *Brazil:* Mezrahi, A.; *Bulgaria:* Bakalova, A.; *Canada:* Viglasky, T.; *China:* Pu, Y.; **Denmark:* Hannibal, L.; *Egypt:* El-Shinawy, R.M.K.; *France:* Aguilar, J.; *Germany:* Rein, H.; *Hungary:* Sáfár, J.; *India:* Nandakumar, A.N.; *Ireland:* Duffy, J.; *Israel:* Koch, J.; *Italy:* Trivelloni, S.; *Japan:* Saito, T.; *Korea, Republic of:* Kwon, S.-G.; *Netherlands:* Van Halem, H.; *Norway:* Hornkjøl, S.; **Peru:* Regalado Campaña, S.; *Romania:* Vieru, G.; *Russian Federation:* Ershov, V.N.; *South Africa:* Jutle, K.; *Spain:* Zamora Martin, F.; *Sweden:* Pettersson, B.G.; *Switzerland:* Knecht, B.; **Thailand:* Jerachanchai, S.; *Turkey:* Köksal, M.E.; *United Kingdom:* Young, C.N. (Chairperson); *United States of America:* Brach, W.E.; McGuire, R.; *European Commission:* Rossi, L.; *International Air Transport Association:* Abouchaar, J.; *IAEA:* Wangler, M.E. (Coordinator); *International Civil Aviation Organization:* Rooney, K.; *International Federation of Air Line Pilots' Associations:* Tisdall, A.; *International Maritime Organization:* Rahim, I.; *International Organization for*

BODIES FOR THE ENDORSEMENT OF SAFETY STANDARDS

Standardization: Malesys, P.; *United Nations Economic Commission for Europe*: Kervella, O.; *World Nuclear Transport Institute*: Lesage, M.

Waste Safety Standards Committee

Argentina: Siraky, G.; *Australia*: Williams, G.; **Belarus*: Rozdyalovskaya, L.; *Belgium*: Baekelandt, L. (Chairperson); *Brazil*: Xavier, A.; **Bulgaria*: Simeonov, G.; *Canada*: Ferch, R.; *China*: Fan, Z.; *Cuba*: Benitez, J.; **Denmark*: Øhlenschlaeger, M.; **Egypt*: Al Adham, K.; Al Sorogi, M.; *Finland*: Ruokola, E.; *France*: Averous, J.; *Germany*: von Dobschütz, P.; *Hungary*: Czoch, I.; *India*: Raj, K.; *Ireland*: Pollard, D.; *Israel*: Avraham, D.; *Italy*: Dionisi, M.; *Japan*: Irie, K.; *Korea, Republic of*: Song, W.; **Madagascar*: Andriambololona, R.; *Mexico*: Aguirre Gómez, J.; Delgado Guardado, J.; *Netherlands*: Selling, H.; **Norway*: Sorlie, A.; *Pakistan*: Hussain, M.; **Peru*: Gutierrez, M.; *Russian Federation*: Poluektov, P.P.; *Slovakia*: Konecny, L.; *South Africa*: Pather, T.; *Spain*: López de la Higuera, J.; Ruiz López, C.; *Sweden*: Wingefors, S.; *Switzerland*: Zurkinden, A.; **Thailand*: Wangcharoenroong, B.; *Turkey*: Osmanlioglu, A.; *United Kingdom*: Wilson, C.; *United States of America*: Greeves, J.; Wallo, A.; *European Commission*: Taylor, D.; *IAEA*: Hioki, K. (Coordinator); *International Commission on Radiological Protection*: Valentin, J.; *International Organization for Standardization*: Hutson, G.; *OECD Nuclear Energy Agency*: Riotte, H.

INDEX

(by paragraph number)

Accident conditions: 106, 402, 636, 671, 682, 726

Activity limits: 201, 230, 401, 411, 815–817

A_1 : 201, 401–410, 413, 414, 416, 559, 820

A_2 : 201, 226, 401–410, 412–414, 416, 550, 559, 601, 605, 657, 658, 669, 730, 820

Air (transport by): 106, 217, 412, 416, 531, 577–579, 581, 617–621, 633, 650, 652, 653, 680, 816, 817

Ambient conditions: 615, 617–619, 643, 651–654, 664, 668, 676, 703, 710, 711, 728, 810, 831, 833

Basic Safety Standards: 101, 308

Carrier: 203, 206, 307, 556, 557, 831

Categories of package: 533, 540, 544, 550, 564, 574

Certificate of approval: 415–418, 502, 545, 550, 558, 560, 562, 566, 676, 801, 804, 805, 808, 811, 814, 823, 826–834

Competent authority: 104, 204, 205, 207–209, 238, 302, 306–308, 310, 402, 510, 538, 539, 545, 550, 557–559, 566, 576, 583, 603, 632, 638, 665, 667, 676, 711, 801, 802, 804, 805, 808, 811, 813–819, 821, 823, 825–834

Compliance assurance: 102, 105, 208, 307

Confinement system: 209, 501, 678

Consignee: 210, 221, 535, 582

Consignment: 203, 204, 210–212, 229, 236–238, 305, 310, 401, 404, 505, 506, 529, 530, 547, 548, 550, 551, 554, 556–560, 565, 567, 568, 571–573, 576, 577, 580, 581, 583, 672, 803, 824, 825, 831–833

Consignor: 211, 212, 221, 229, 306, 307, 505, 535, 549–553, 556–559, 561, 562, 581, 801, 831–833

Containment: 104, 618, 651

Containment system: 213, 228, 501, 502, 619, 630, 639–643, 645, 648, 658, 660, 661, 670, 677, 682, 714, 716, 724, 807

Contamination: 214–216, 241, 508–510, 512, 513, 520, 523, 657, 669

INDEX

Conveyance: 104, 217, 221, 223, 411, 510, 512–514, 523, 525, 527, 556, 567, 570, 606, 672, 807, 822, 831, 832

Cooling system: 578, 659

Criticality: 101, 104, 209, 567–570, 716, 820, 831–833

Criticality safety index: 218, 528–530, 545, 546, 550, 567–570, 820, 831, 833

Customs: 582

Dangerous goods: 109, 506, 507, 563

Deck area: 217, 219

Decontamination: 513

Dose limits: 301

Emergency: 102, 304, 305, 556, 831–833

Empty packaging: 520, 555

Excepted package: 222, 226, 230, 408–410, 514–520, 536, 542, 547, 550, 555, 576, 620, 649, 671, 672, 709, 731, 802, 812, 815, 828, 829

Exclusive use: 221, 505, 514, 523, 530–533, 541, 548, 550, 567, 568, 571–573, 575, 577, 652, 663

Fissile material: 209, 218, 222, 226, 230, 418, 501, 502, 507, 515, 522, 528, 542, 544, 546, 550, 560, 569, 570, 629, 671–682, 716, 731–733, 802, 806, 809, 812–814, 816, 817, 820, 828, 829, 831–833

Freight container: 218, 221, 223, 231, 243, 509, 514, 526, 527, 542–544, 546–548, 550, 556, 563, 567, 569–571, 574, 627, 807, 831, 832

Gas: 242, 642, 649

Heat: 104, 501, 556, 566, 603, 651, 704, 708, 728, 807, 831–833

Identification mark: 539, 550, 804, 805, 808, 811, 814, 828–833

Industrial package: 230, 411, 412, 521, 524, 525, 538, 621–628, 815, 828, 829

Insolation: 617, 653, 655, 728

Inspection: 302, 306, 307, 502, 582, 801

Intermediate bulk container: 224, 231, 504, 509, 514, 628

INDEX

- Label: 520, 539, 540, 542–547, 551, 555, 571, 574
- Leaching: 226, 603, 704, 710, 711
- Leakage: 510, 603, 619, 630, 632, 644, 648, 677, 680, 704, 710, 711, 731–733
- Low dispersible radioactive material: 220, 225, 306, 307, 416, 502, 550, 560, 605, 663, 701, 712, 802–804, 806, 809, 827, 828, 830–833
- Low specific activity: 226, 243, 411, 412, 503, 521–526, 541, 544, 548, 550, 567, 572, 601, 626, 701, 703
- Maintenance: 104, 106, 306, 307, 677, 807, 832
- Manufacture: 106, 306, 307, 677, 713, 807, 816, 817, 831, 833
- Marking: 507, 517, 518, 535, 541, 543, 549, 829
- Mass: 240, 246, 418, 419, 537, 544, 550, 560, 606, 608, 657, 672, 673, 682, 709, 722–724, 727, 735, 831, 833
- Maximum normal operating pressure: 228, 661, 662, 668, 669, 807
- Multilateral approval: 204, 310, 402, 718, 803, 805, 806, 809, 812, 816, 817, 820, 824, 828, 829, 834
- N: 528, 681, 682
- Normal conditions: 106, 511, 651, 681, 719
- Notification: 204, 558–561, 819
- Operational controls: 228, 578, 666, 810, 822, 825, 831–833
- Other dangerous properties: 507, 542, 616
- Overpack: 218, 229, 243, 509, 514, 526, 527, 530, 531, 533, 542–544, 546, 550, 556, 563, 564, 566–571, 573–575, 579
- Package design: 415–418, 538–540, 545, 550, 558, 616, 676, 801, 805, 806, 809, 810, 812, 816, 817, 822, 827–829, 833
- Packaging: 104, 106, 209, 213, 220, 224, 226, 230, 231, 235, 306, 307, 503, 520, 535–539, 555, 581, 609, 613, 629, 637, 641, 645, 651, 663, 675, 677, 678, 701, 718, 723, 807, 815–817, 819, 829, 831–833
- Placard: 547, 548, 571, 572
- Post: 410, 515, 536, 580, 581

INDEX

Pressure: 228, 231, 419, 501, 502, 619, 625, 631, 632, 639, 643, 644, 660–662, 668, 669, 718, 729, 730, 807

Pressure relief: 231, 631, 644, 660

Quality assurance: 102, 105, 232, 306, 803, 805, 807, 813, 815–818, 830–833

Radiation exposure: 243, 563, 582

Radiation level: 104, 233, 411, 510, 513, 516, 517, 521, 526, 527, 530–533, 567, 573, 575, 579, 605, 622, 624, 625, 627, 628, 646, 657, 669

Radiation protection: 101, 234, 302, 576, 603, 711, 802, 820

Rail (transport by): 217, 242, 531, 571, 572

Responsibility: 103, 307, 549

Road (transport by): 217, 242, 247, 531, 571–574

Routine conditions: 106, 215, 508, 518, 523, 567, 573, 612, 615, 625, 627, 679

Segregation: 563, 569

Serial number: 539, 816, 819

Shielding: 226, 231, 501, 523, 622, 624, 625, 627, 628, 646, 651, 657, 669, 716

Shipment: 204, 237, 501, 502, 550, 558–562, 573, 576, 674, 677, 802, 803, 807, 820–834

Shipping: 536, 550, 551

Special arrangement: 238, 310, 531, 533, 545, 550, 559, 575, 579, 824–829, 831

Special form: 201, 220, 239, 306, 307, 413, 414, 416, 502, 550, 560, 602–604, 640, 657, 701, 704, 709, 802–804, 818, 827, 828, 830–833

Specific activity: 226, 240, 503

Storage: 563, 565, 569

Stowage: 219, 229, 307, 556, 565, 566, 576, 807, 831–833

Surface contaminated objects: 241, 243, 411, 503, 504, 521–526, 541, 544, 548, 550, 572

Tank: 231, 242, 504, 509, 514, 526, 542, 543, 547, 548, 571, 625, 626

Tank container: 242

Tank vehicle: 242

INDEX

- Temperature: 228, 419, 502, 617, 637, 647, 652–654, 664, 668, 671, 675, 676, 703, 708–711, 728, 810, 831, 833
- Tests: 224, 502, 603, 605, 622, 624, 627, 628, 646, 648, 649, 651, 656, 657, 660, 661, 668, 669, 675, 677–682, 701, 702, 704, 709, 711–713, 716, 717, 719, 725–727, 732, 734, 803, 807
- Tie-down: 231, 242, 636
- Transport documents: 212, 544, 550, 551, 556
- Transport index: 243, 526, 527, 530, 533, 544, 550, 567, 568
- Type A package: 230, 413, 414, 538, 633–649, 725, 815, 828
- Type B(M) package: 230, 415, 416, 539, 559, 577, 579, 665, 666, 730, 802, 809, 810, 811, 820, 828, 829, 833
- Type B(U) package: 230, 650–664, 802, 806, 808, 828
- Type C package: 230, 417, 501, 502, 539, 540, 559, 667–670, 730, 734–737, 802, 806, 808, 828
- Ullage: 419, 647
- Unilateral approval: 205, 502, 803, 805, 806, 818, 828
- United Nations number: 536, 547, 548, 550, 572
- Unpackaged: 223, 243, 517, 521, 523, 525, 526, 548, 572, 672
- Uranium hexafluoride: 230, 419, 526, 629–632, 677, 718, 802, 805, 828, 829
- Vehicle: 217, 219, 242, 247, 538, 571–575, 828
- Venting: 228, 231, 666, 820
- Vessel: 217, 219, 248, 531, 575, 576, 802, 820
- Water: 106, 217, 226, 525, 540, 601, 603, 605, 610, 658, 670, 671, 677, 678, 680–682, 703, 710, 711, 719–721, 726, 729, 730–733, 831, 833

Safety through international standards

“The IAEA’s standards have become a key element of the global safety regime for the beneficial uses of nuclear and radiation related technologies.

“IAEA safety standards are being applied in nuclear power generation as well as in medicine, industry, agriculture, research and education to ensure the proper protection of people and the environment.”

**Mohamed ElBaradei
IAEA Director General**

**INTERNATIONAL ATOMIC ENERGY AGENCY
VIENNA
ISBN 92-0-103005-3
ISSN 1020-525X**